

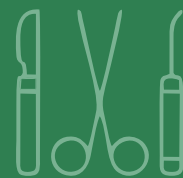

FIVE S SURGICAL



Surgical Product CATALOG



✉ Info@fivessurgical.com

☎ +923216164663

🌐 fivessurgical.com

TABLE OF CONTENT

01.	Diagnostic	03
02.	Scissors	07
03.	Needle Holder	42
04.	Ophthalmic	62
05.	Neuro	81
06.	Ent	85
07.	Hollow Ware	109
08.	Plastic Surgery	115
09.	Orthopedic	126
10.	Retractors	166
11.	Dermal & Rectal	181

DIAGNOSTIC

01

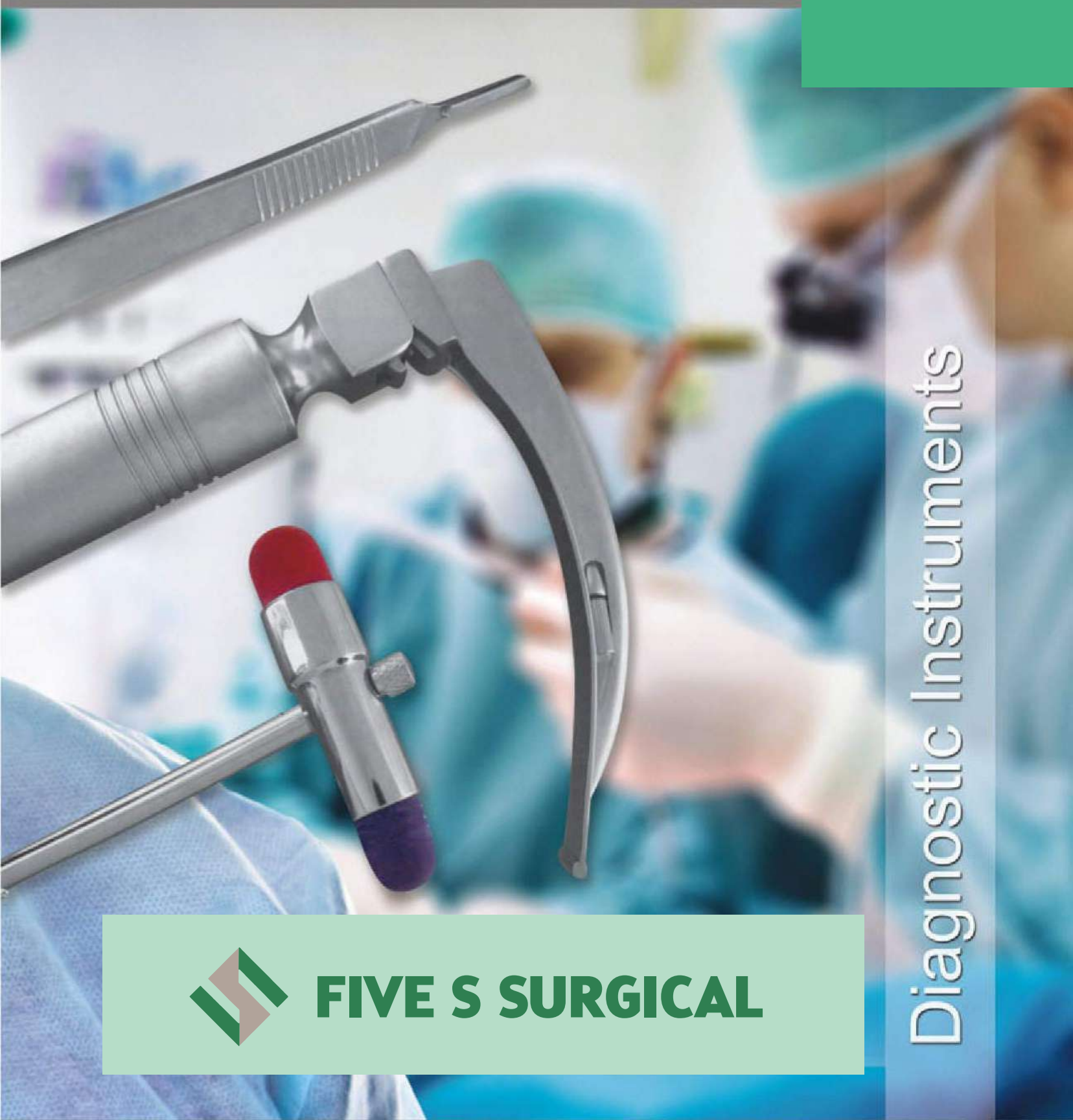

Diagnostic Instruments



FIVE S SURGICAL



1/1
Standard
01-001-03
No. 3



1/1
01-002-04
No. 4



1/1
01-003-05
No. 3 Graduated



1/1
01-004-31
No. 3L



1/1
01-005-35
No. 3L cvd



DIAGNOSTIC INSTRUMENTS

Scalpel Handles



1/1
01-006-41
No. 4L

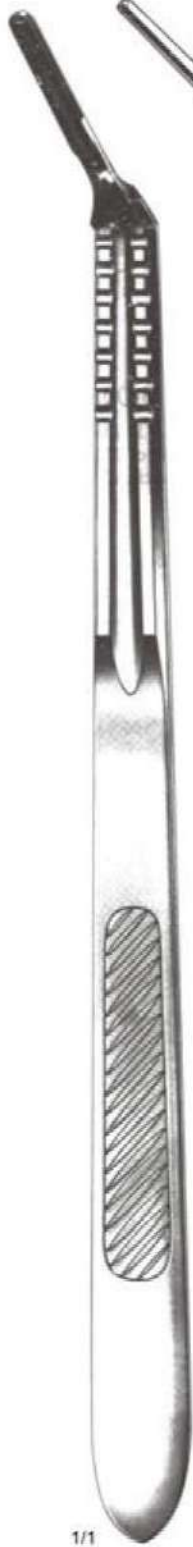

1/1
01-007-45
No. 4L cvd

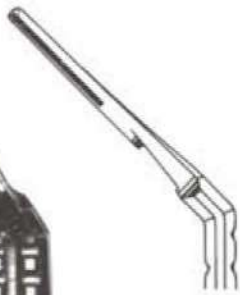

1/1
01-008-07
No. 7



1/1
01-009-71
No. 7K



1/1
01-010-03
No. 3 Round



1/1
01-011-03
No. 3 Round cvd



Taylor
01-012-20
20 cm / 8"



Buck
01-013-18
18 cm / 7"



Déjerine
01-014-21
21 cm / 8 1/4"



Wartenberg
01-015-19
19 cm / 7 1/2"

SCISSORS

02



Scissors



FIVE S SURGICAL

SCISSORS

Operating Scissors

Inches



1/1

02-001-10
10.5 cm / 4 1/4"

02-001-11
11.5 cm / 4 1/2"

02-001-13
13 cm / 5"

02-001-14
14.5 cm / 5 1/2"

02-001-15
15.5 cm / 6"

02-001-16
16.5 cm / 6 1/2"

Standard / Op. Scissor (Str.)
02-001-10 - 02-001-16



1/1

02-002-11
11.5 cm / 4 1/4"

02-002-13
13.5 cm / 5"

02-002-14
14.5 cm / 5 1/2"

02-002-15
15.5 cm / 6"

02-002-16
16.5 cm / 6 1/2"

Standard / Op. Scissor (Cvd.)
02-002-11 - 02-002-16



SCISSORS

Operating Scissors



Standard / Op. Scissor (Str.)
02-003-11 - 02-003-18

1/1

02-003-11
11.5 cm / 4½"

02-003-13
13 cm / 5"

02-003-14
14.5 cm / 5½"

02-003-16
16.5 cm / 6½"

02-003-18
18.5 cm / 7½"

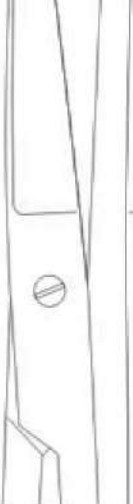
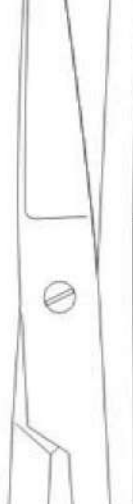
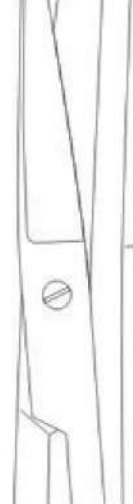

Standard / Op. Scissor (Cvd.)
02-004-11 - 02-004-18

1/1

02-004-11
11.5 cm / 4½"

02-004-13
13 cm / 5"

02-004-14
14.5 cm / 5½"

02-004-16
16.5 cm / 6½"

02-004-18
18.5 cm / 7½"

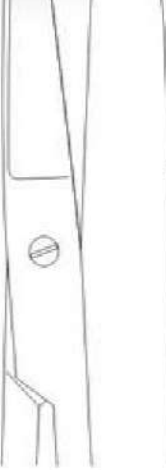
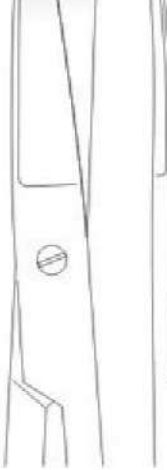
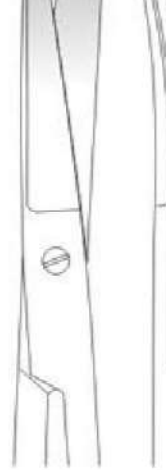
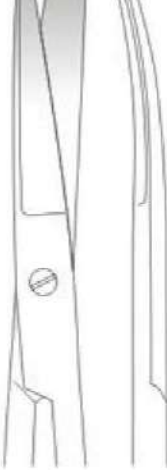

SCISSORS

Operating Scissors

Inches

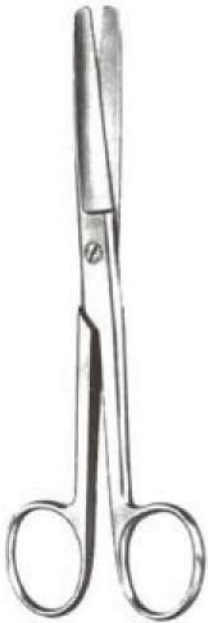

Standard / Op. Scissor (Str.)
02-005-11 - 02-005-18

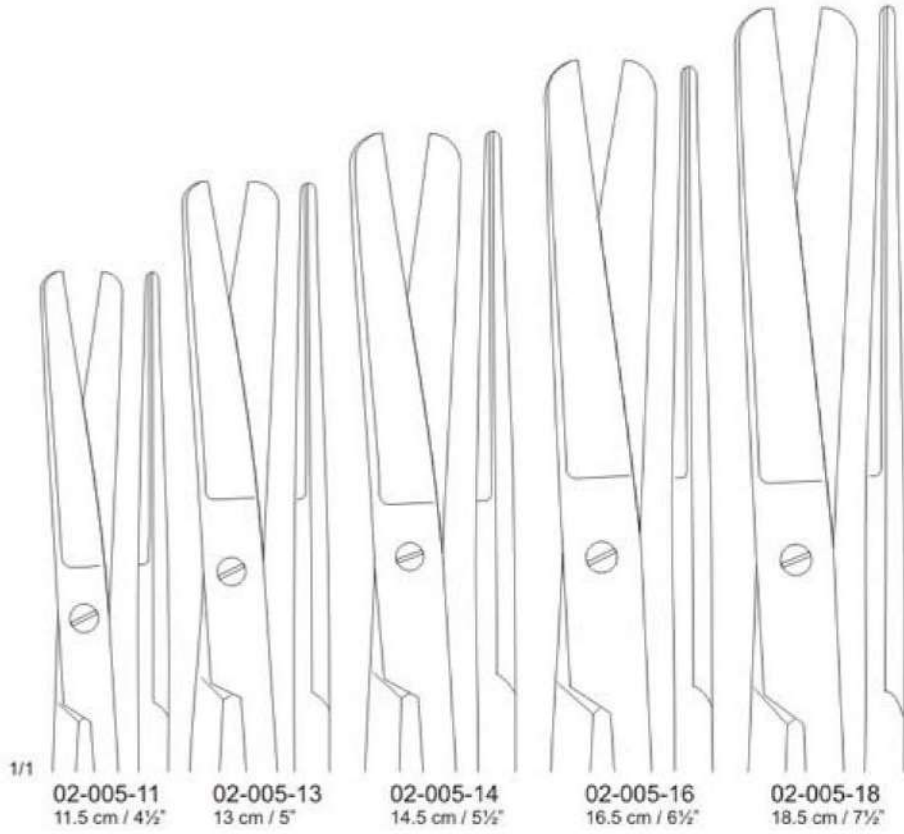

02-005-11 11.5 cm / 4½"	02-005-13 13 cm / 5"	02-005-14 14.5 cm / 5½"	02-005-16 16.5 cm / 6½"	02-005-18 18.5 cm / 7½"
----------------------------	-------------------------	----------------------------	----------------------------	----------------------------



Standard / Op. Scissor (Cvd.)
02-006-11 - 02-006-18

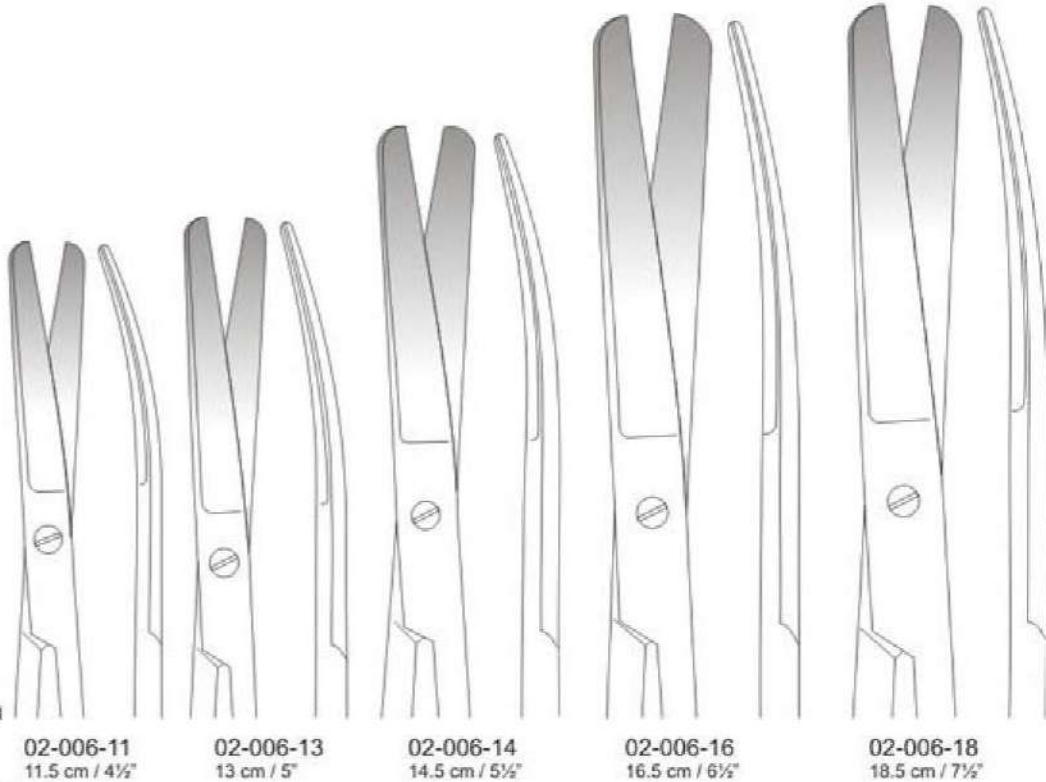

02-006-11 11.5 cm / 4½"	02-006-13 13 cm / 5"	02-006-14 14.5 cm / 5½"	02-006-16 16.5 cm / 6½"	02-006-18 18.5 cm / 7½"
----------------------------	-------------------------	----------------------------	----------------------------	----------------------------



SCISSORS

Operating Scissors

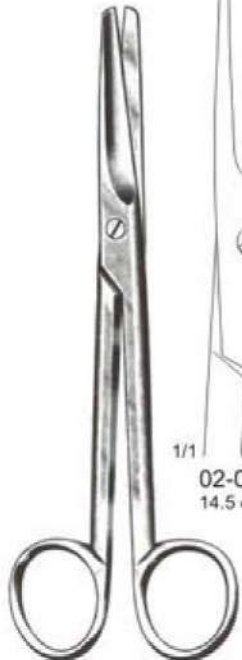

Mayo
02-007-14 - 02-008-23

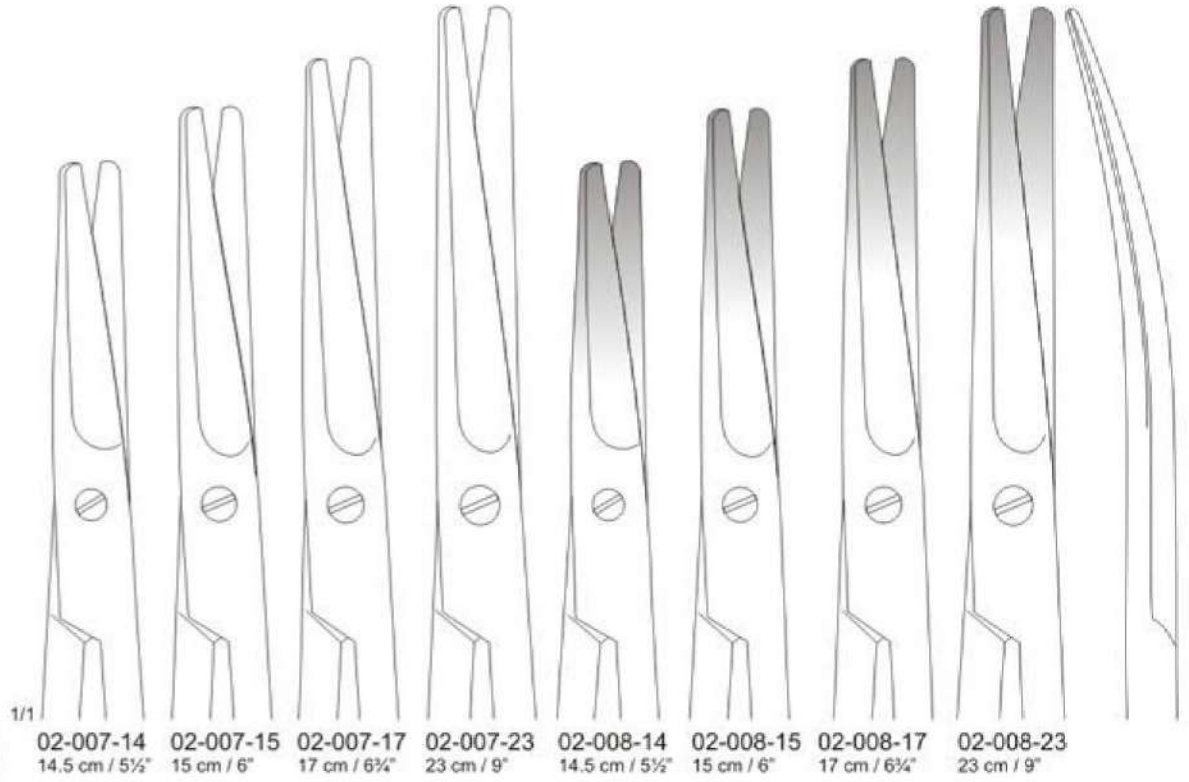

02-007-14	02-007-15	02-007-17	02-007-23	02-008-14	02-008-15	02-008-17	02-008-23
14.5 cm / 5 1/2"	15 cm / 6"	17 cm / 6 3/4"	23 cm / 9"	14.5 cm / 5 1/2"	15 cm / 6"	17 cm / 6 3/4"	23 cm / 9"



Mayo-Stillie
02-009-15 - 02-010-17

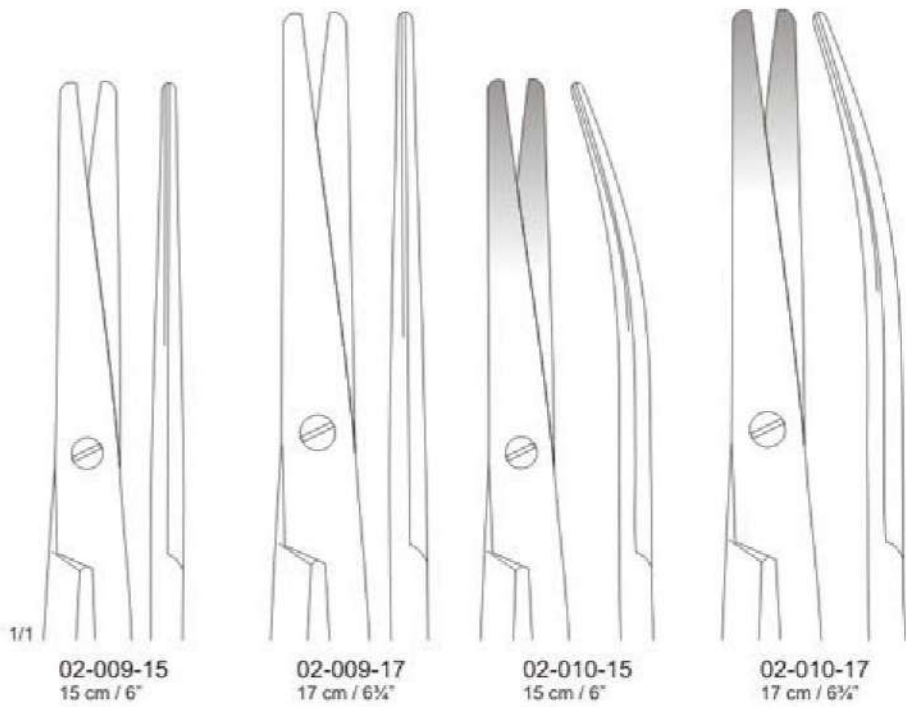

02-009-15	02-009-17	02-010-15	02-010-17
15 cm / 6"	17 cm / 6 3/4"	15 cm / 6"	17 cm / 6 3/4"

SCISSORS

Operating Scissors

Inches



Mayo-Noble
02-011-17 - 02-012-17
17 cm / 6 1/2"

1/1

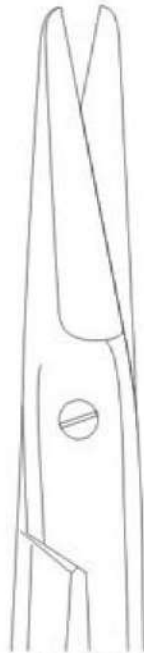

02-011-17

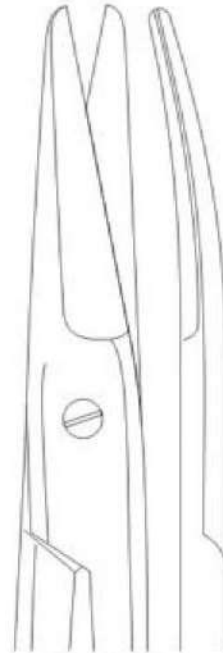

02-012-17



Kelly
02-013-16 - 02-014-18

1/1

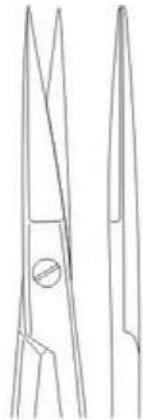

02-013-16
16 cm / 6 1/4"

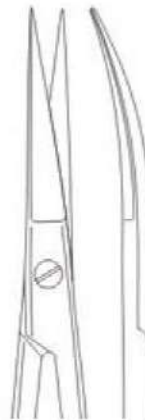

02-014-16
16 cm / 6 1/4"



Metzenbaum (Baby)
02-015-11 - 02-016-11
11.5 cm / 4 1/2"

1/1



02-015-11



02-016-11



SCISSORS

Fine Operating Scissors



Metzenbaum
02-017-14 - 02-022-14

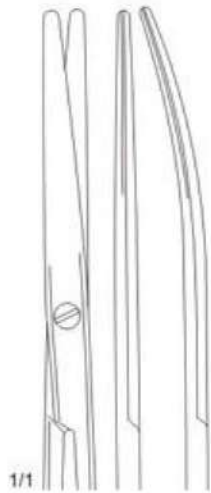

- 02-017-14 14 cm / 5½" str
- 02-018-14 14 cm / 5½" cvd
- 02-017-15 15 cm / 6" str
- 02-018-15 15 cm / 6" cvd
- 02-017-18 18 cm / 7" str
- 02-018-18 18 cm / 7" cvd
- 02-017-20 20 cm / 8" str
- 02-018-20 20 cm / 8" cvd
- 02-017-23 23 cm / 9" str
- 02-018-23 23 cm / 9" cvd
- 02-017-25 25 cm / 10" str
- 02-018-25 25 cm / 10" cvd
- 02-017-28 28 cm / 11" str
- 02-018-28 28 cm / 11" cvd
- 02-017-30 30 cm / 12" str
- 02-018-30 30 cm / 12" cvd

B/B

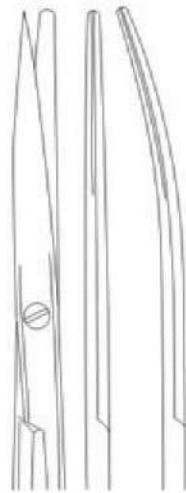

- 02-019-14 14 cm / 5½" str
- 02-020-14 14 cm / 5½" cvd
- 02-019-15 15 cm / 6" str
- 02-020-15 15 cm / 6" cvd
- 02-019-18 18 cm / 7" str
- 02-020-18 18 cm / 7" cvd
- 02-019-20 20 cm / 8" str
- 02-020-20 20 cm / 8" cvd
- 02-019-23 23 cm / 9" str
- 02-020-23 23 cm / 9" cvd
- 02-019-25 25 cm / 10" str
- 02-020-25 25 cm / 10" cvd
- 02-019-28 28 cm / 11" str
- 02-020-28 28 cm / 11" cvd
- 02-019-30 30 cm / 12" str
- 02-020-30 30 cm / 12" cvd

S/B

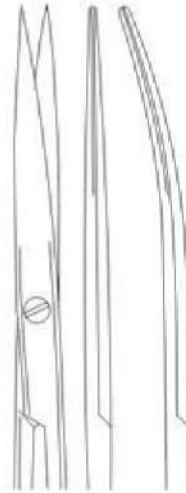

- 02-021-14 14 cm / 5½" str
- 02-022-14 14 cm / 5½" cvd
- 02-021-15 15 cm / 6" str
- 02-022-15 15 cm / 6" cvd
- 02-021-18 18 cm / 7" str
- 02-022-18 18 cm / 7" cvd
- 02-021-20 20 cm / 8" str
- 02-022-20 20 cm / 8" cvd
- 02-021-23 23 cm / 9" str
- 02-022-23 23 cm / 9" cvd
- 02-021-25 25 cm / 10" str
- 02-022-25 25 cm / 10" cvd
- 02-021-28 28 cm / 11" str
- 02-022-28 28 cm / 11" cvd
- 02-021-30 30 cm / 12" str
- 02-022-30 30 cm / 12" cvd

S/S



Iris
02-023-11 - 02-026-11
11.5 cm / 4½"

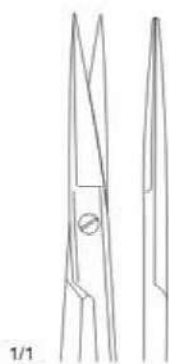

02-023-11

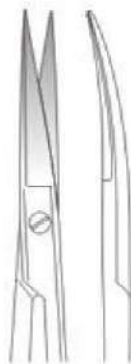

02-024-11



02-025-11



02-026-11



Iris
02-027-09 - 02-028-10

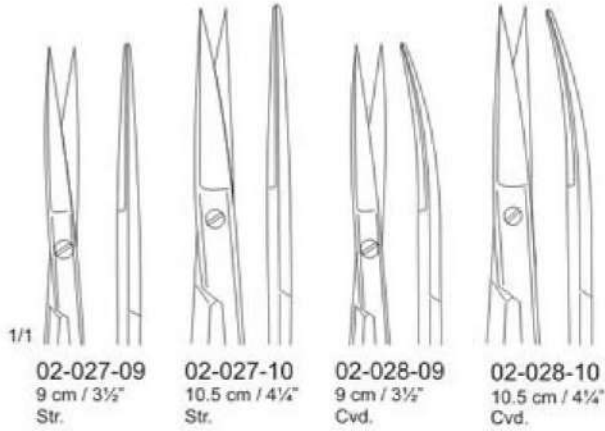

1/1
02-027-09 9 cm / 3½" Str.
02-027-10 10.5 cm / 4¼" Str.
02-028-09 9 cm / 3½" Cvd.
02-028-10 10.5 cm / 4¼" Cvd.



Stevens
02-029-11 - 02-032-11
11.5 cm / 4½"

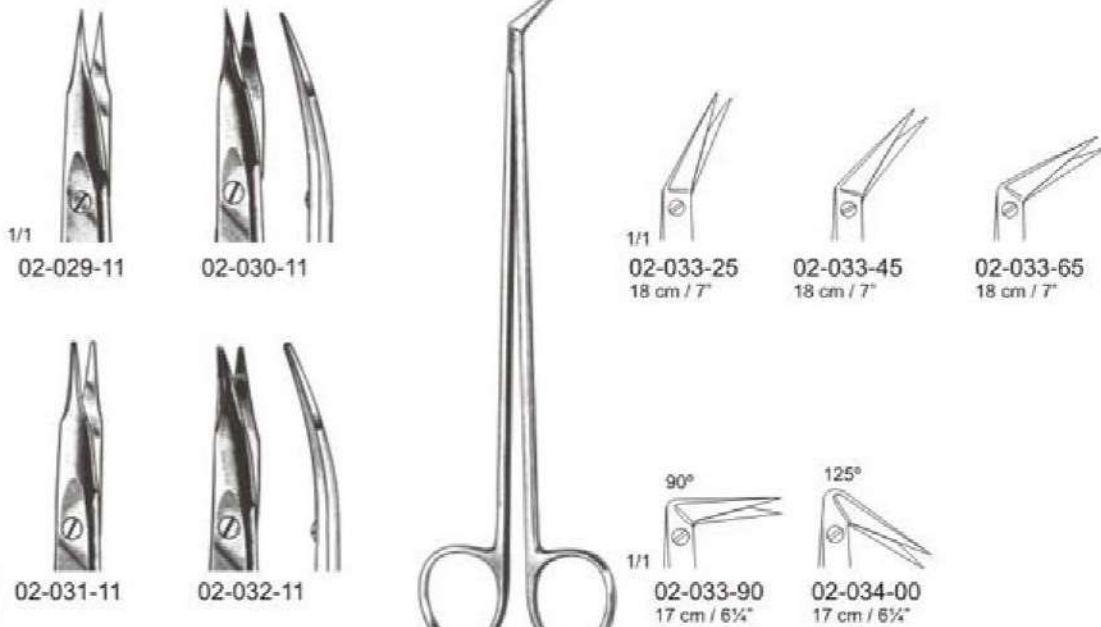

1/1
02-029-11 02-030-11
02-031-11 02-032-11
02-033-25 18 cm / 7"
02-033-45 18 cm / 7"
02-033-65 18 cm / 7"
90° 125°
1/1 02-033-90 17 cm / 6¾"
02-034-00 17 cm / 6¾"



SCISSORS

Thorax, Vascular & Stitch Scissors



Potts-Smith
02-035-19 - 02-037-19
19 cm / 7½"

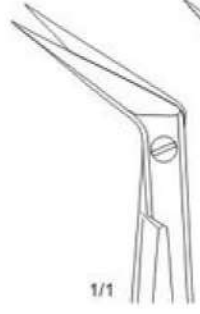

1/1
02-035-19
19 cm / 7½"

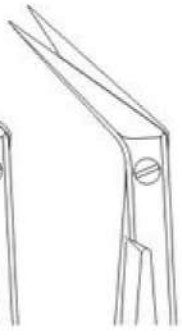

02-036-19
19 cm / 7½"



02-037-19
19 cm / 7½"



Jameson
02-038-15
15 cm / 6"



1/1



Jameson
02-039-13
13 cm / 5"



1/1



Spencer
02-040-09
09 cm / 3½"



Spencer
02-040-13
13 cm / 5"



Littauer
02-040-14
14 cm / 5½"



SCISSORS

Gynecological & Operating Scissors

Inches



Sims
02-041-20 - 02-042-23

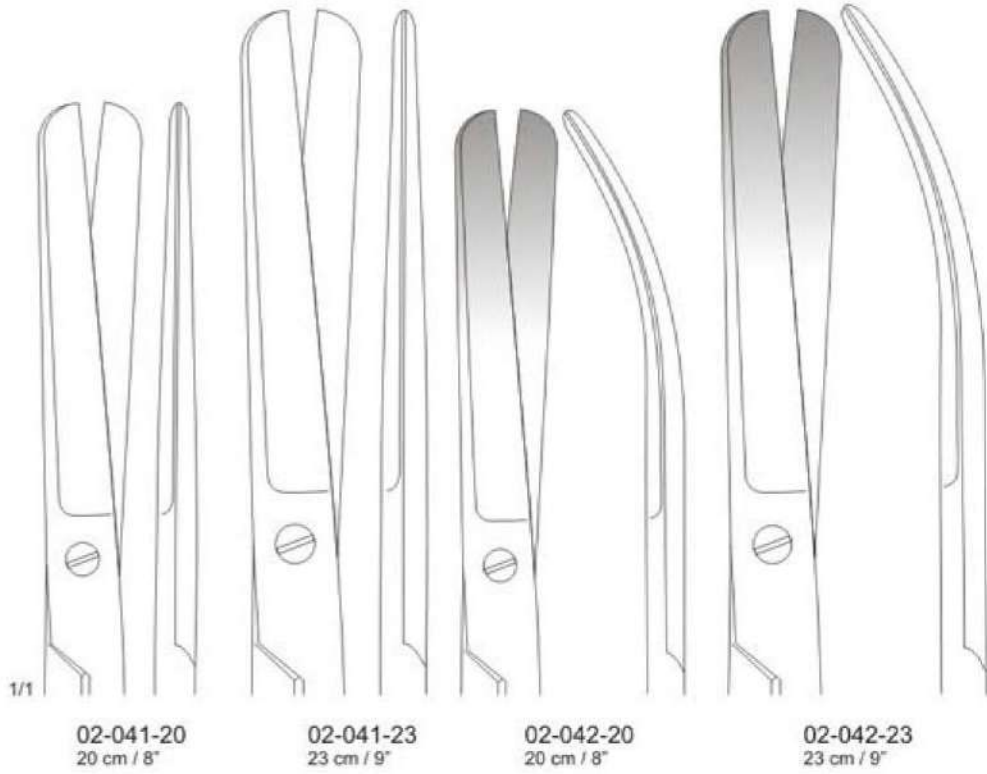

02-041-20
20 cm / 8"

02-041-23
23 cm / 9"

02-042-20
20 cm / 8"

02-042-23
23 cm / 9"

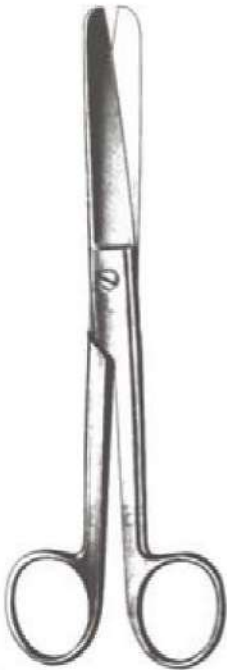

Doyen
02-043-17 - 02-044-17

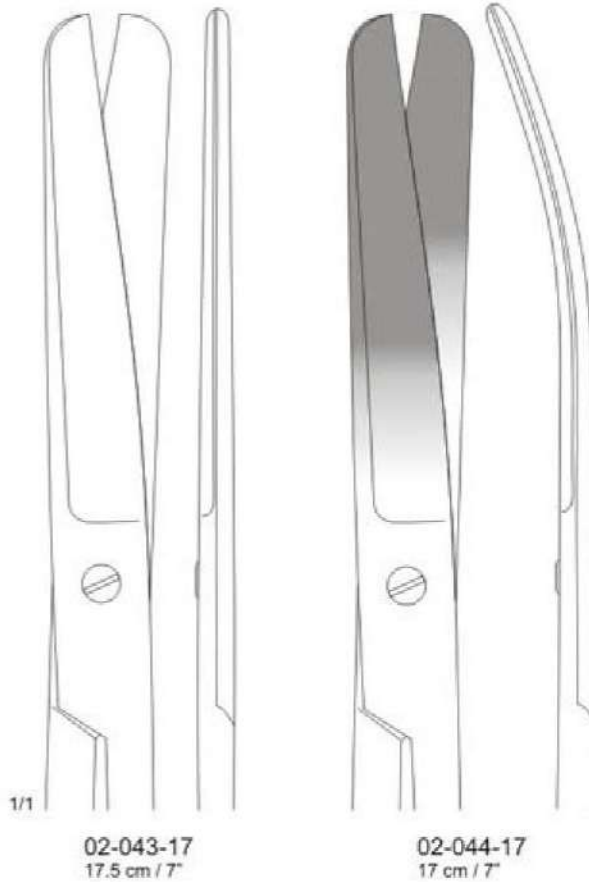

02-043-17
17.5 cm / 7"

02-044-17
17 cm / 7"



SCISSORS

Clothing Scissors, Plaster & Bandage Shears



Lister
 02-045-09 9 cm / 3½"
 02-045-14 14 cm / 5½"
 02-045-18 18 cm / 7"
 02-045-20 20 cm / 8"

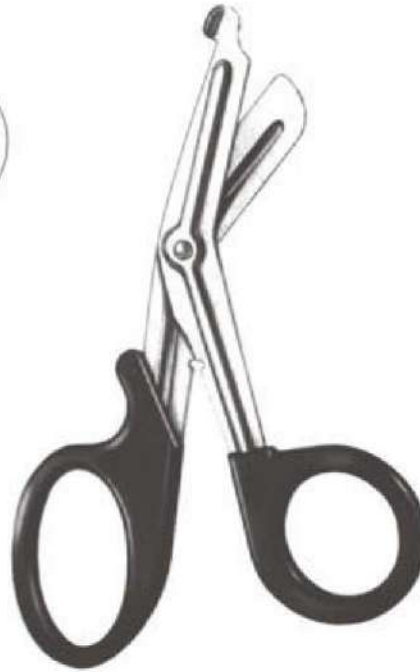
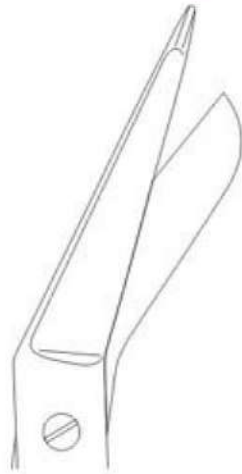

Lister Utility
 02-046-15 15 cm / 6"
 02-046-18 18 cm / 7"



Richter
 02-047-13 13 cm / 5½"
 02-047-14 14,5 cm / 5¾"



Bergmann
 02-048-23 23 cm / 9"

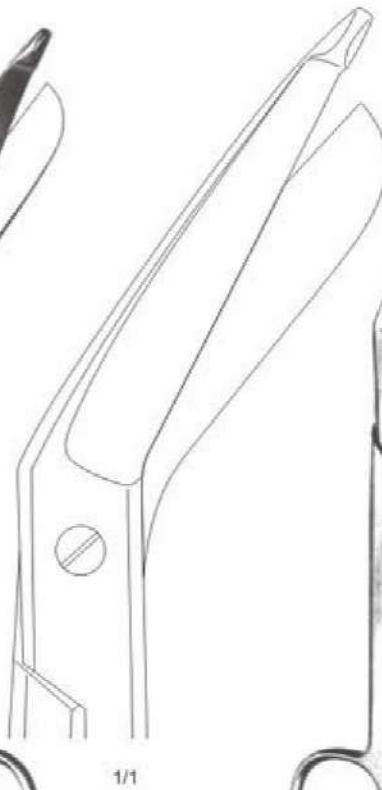

1/1

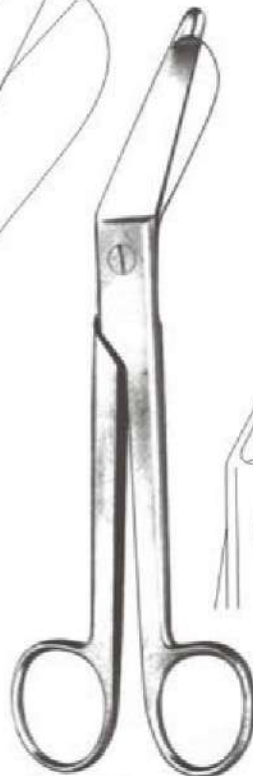

Esmarch
 02-049-20 20 cm / 8"
 02-049-22 22 cm / 8¾"

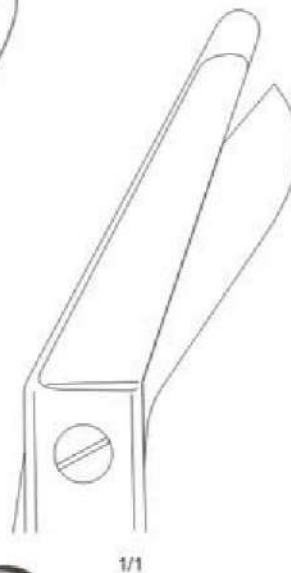

1/1



Richter
 02-050-20 13 cm / 5½"
 02-050-22 14,5 cm / 8¾"



SCISSORS

Episiotomy Scissors

Inches



1/1

Braun-Stadler
02-051-14
14.5 cm / 5½"

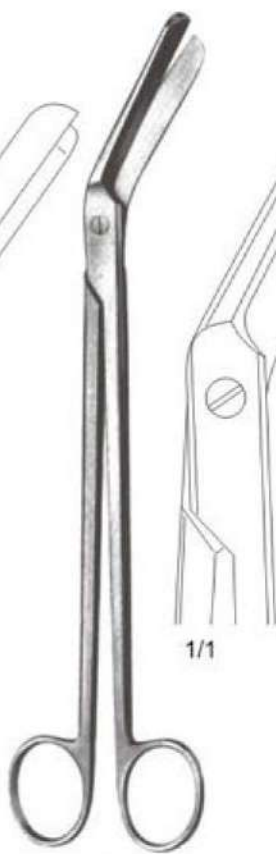

1/1

Braun-Stadler
02-052-22
22 cm / 8¾"

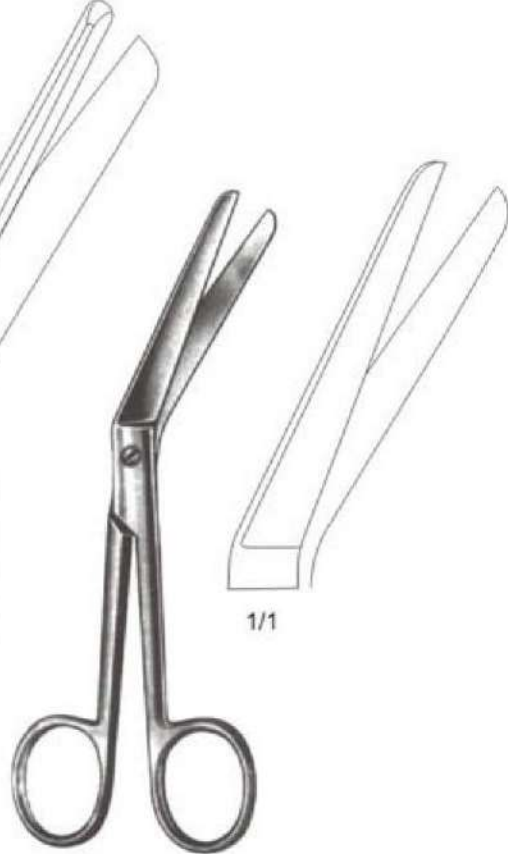

1/1

Richter
02-053-13 13 cm / 5¼"
02-053-14 14.5 cm / 5½"



Busch
02-054-16
16 cm / 6¼"



1/1

Mod. USA
02-055-10
10.5 cm / 4¼"

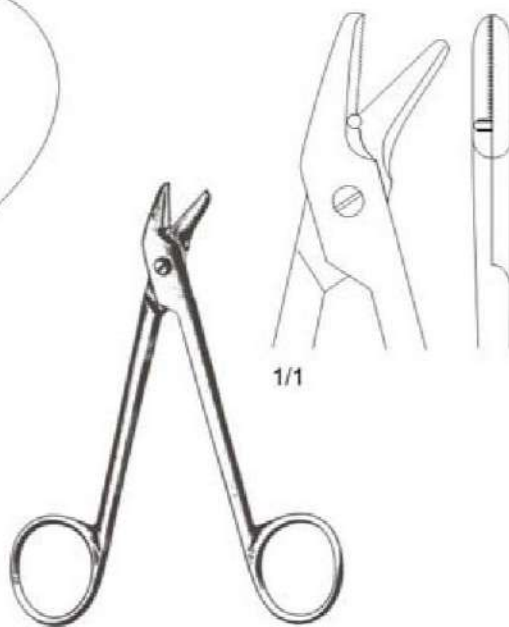

1/1

Universal
02-056-12
12 cm / 4¾"





SCISSORS

Operating Scissors



Standard TC (Str.)
02-057-12 - 02-057-15

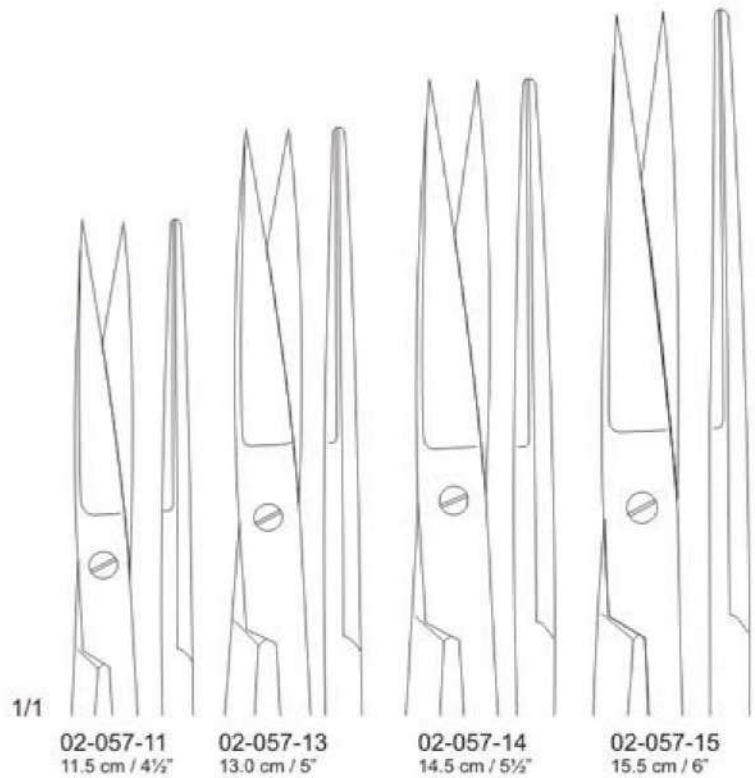

Standard TC (Cvd.)
02-058-11 - 02-058-16

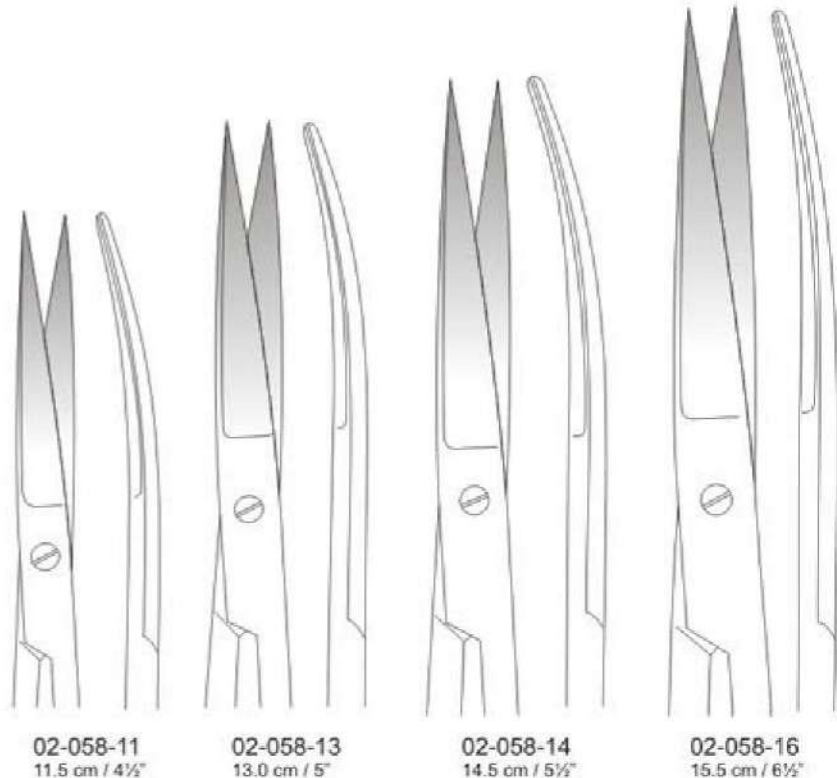

SCISSORS

Operating Scissors

Inches



Standard TC (S/B, Str.)
02-059-11 - 02-059-18

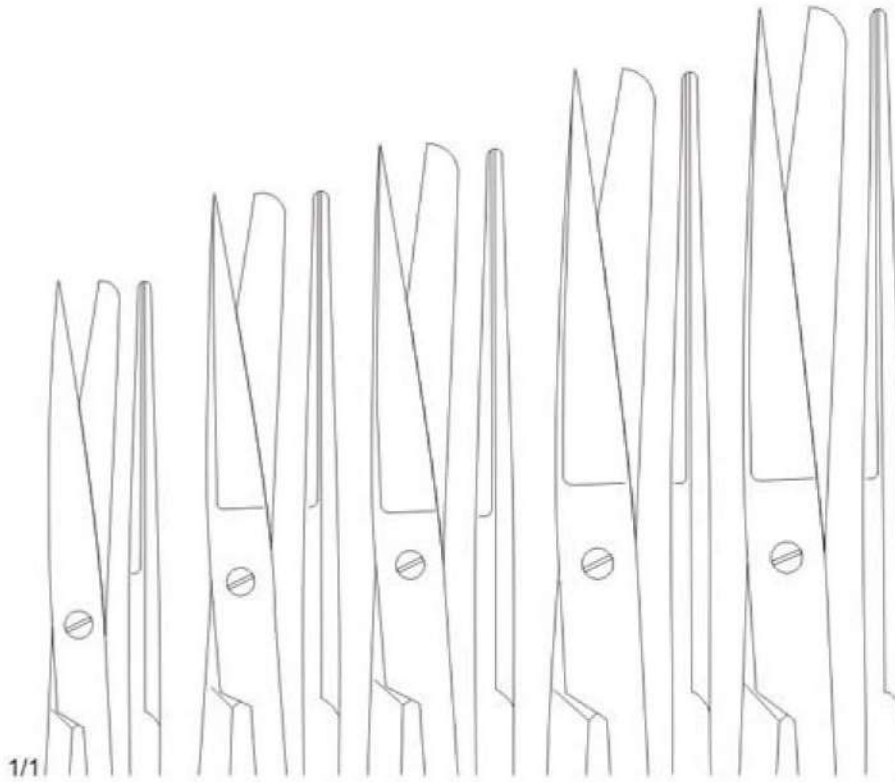

1/1	02-059-11 11.5 cm / 4½"	02-059-13 13.0 cm / 5"	02-059-14 14.5 cm / 5½"	02-059-16 16.5 cm / 6½"	02-059-18 18 cm / 7½"
-----	----------------------------	---------------------------	----------------------------	----------------------------	--------------------------



Standard TC (S/B, Cvd.)
02-060-11 - 02-060-18

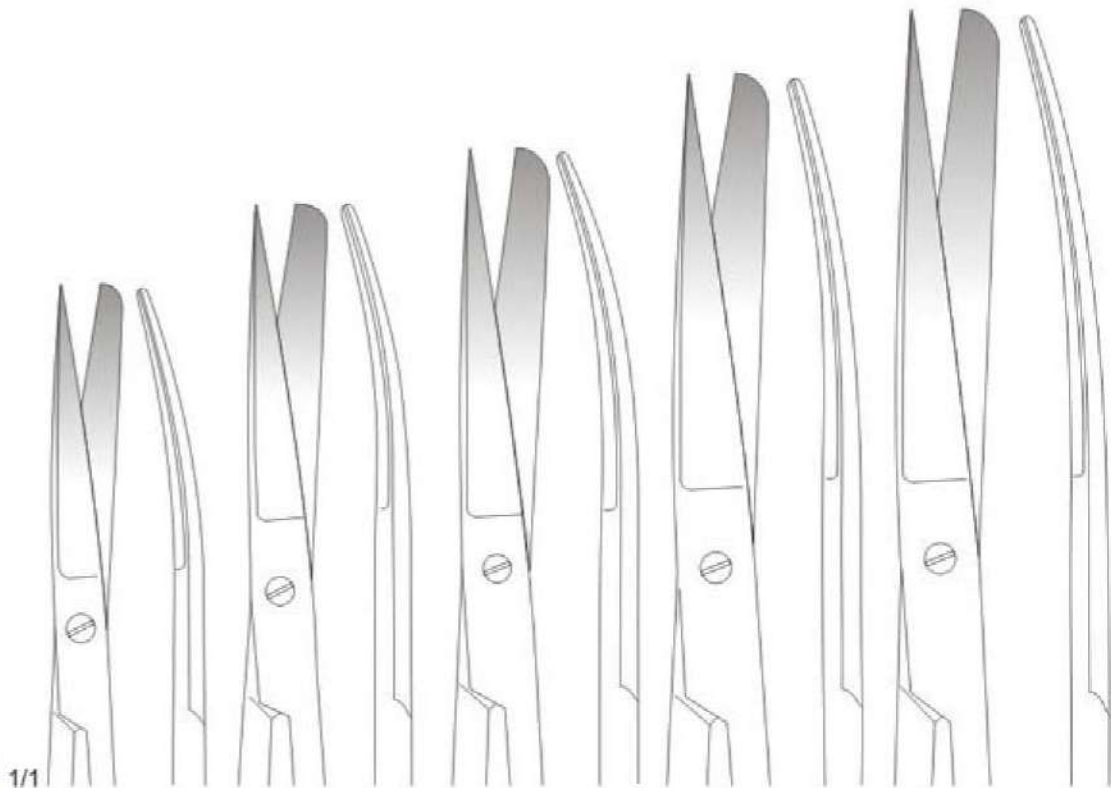

1/1	02-060-11 11.5 cm / 4½"	02-060-13 13.0 cm / 5"	02-060-14 14.5 cm / 5½"	02-060-16 16.5 cm / 6½"	02-060-18 18 cm / 7½"
-----	----------------------------	---------------------------	----------------------------	----------------------------	--------------------------





TUNGSTEN CARBIDE SCISSORS

Operating Scissors



Standard TC (B/B, Str.)
02-061-10 - 02-061-18

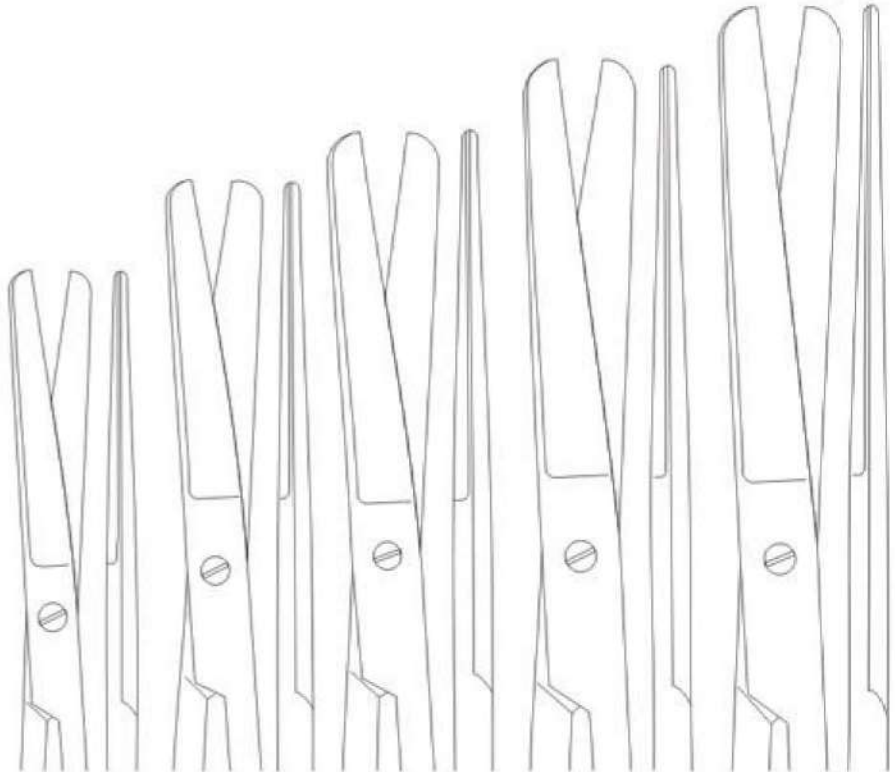

02-061-11
11.5 cm / 4 1/2"

02-061-13
13.0 cm / 5"

02-061-14
14.5 cm / 5 1/2"

02-061-16
16.5 cm / 6 1/2"

02-061-18
18.5 cm / 7 1/2"



Standard TC (B/B, Cvd.)
02-062-11 - 02-062-18

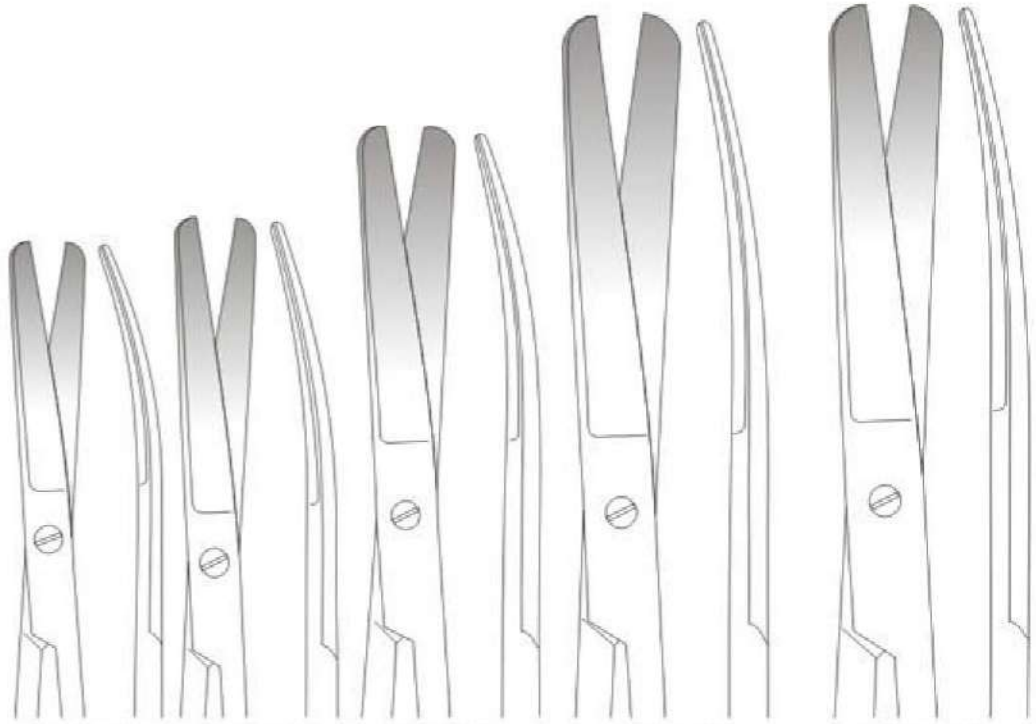

02-062-11
11.5 cm / 4 1/2"

02-062-13
13.0 cm / 5"

02-062-14
14.5 cm / 5 1/2"

02-062-16
16.5 cm / 6 1/2"

02-062-18
18.5 cm / 7 1/2"

TUNGSTEN CARBIDE SCISSORS

Operating Scissors

Inches

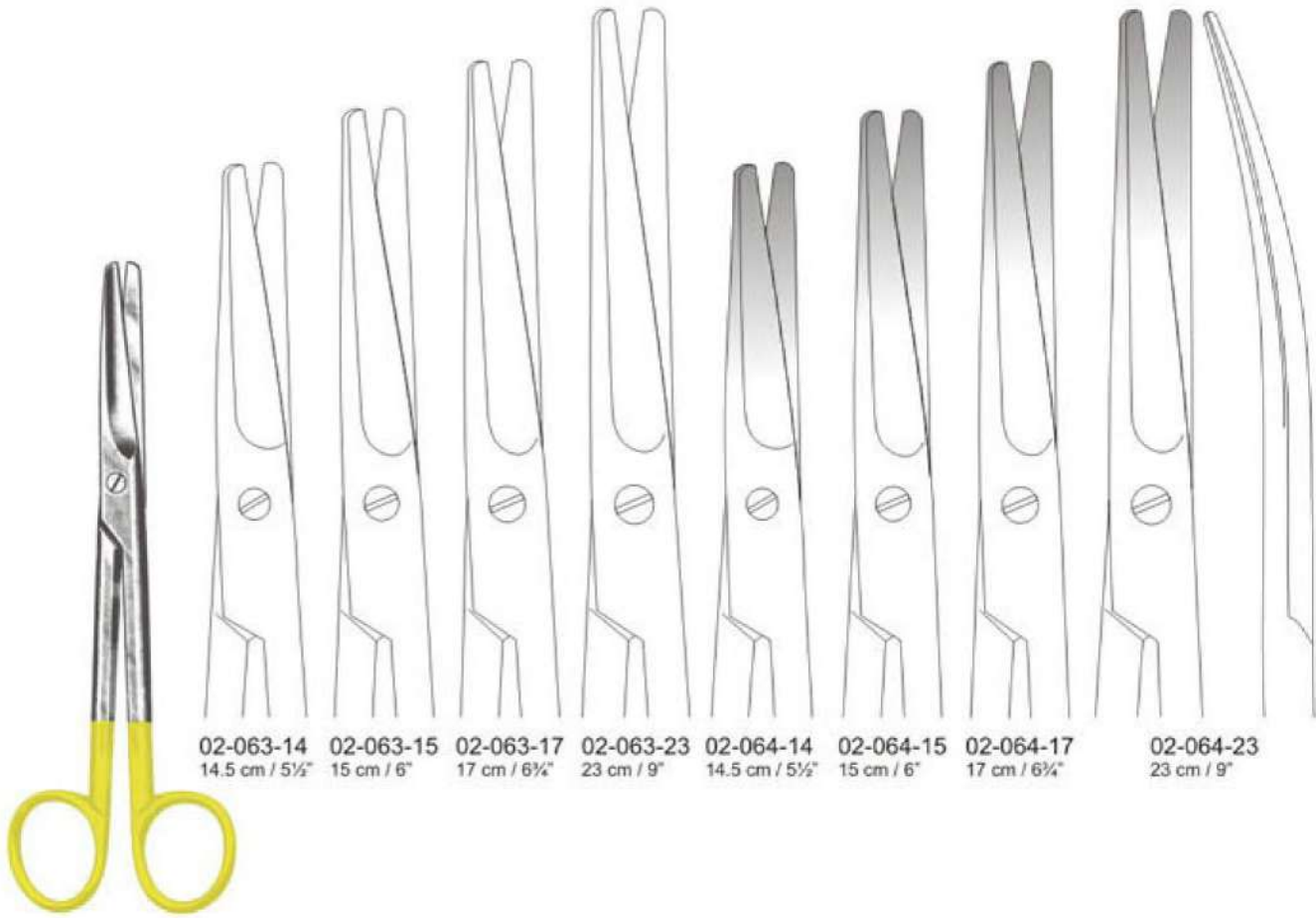

02-063-14	02-063-15	02-063-17	02-063-23	02-064-14	02-064-15	02-064-17	02-064-23
14.5 cm / 5½"	15 cm / 6"	17 cm / 6¾"	23 cm / 9"	14.5 cm / 5½"	15 cm / 6"	17 cm / 6¾"	23 cm / 9"

Mayo TC
02-063-14 - 02-064-28

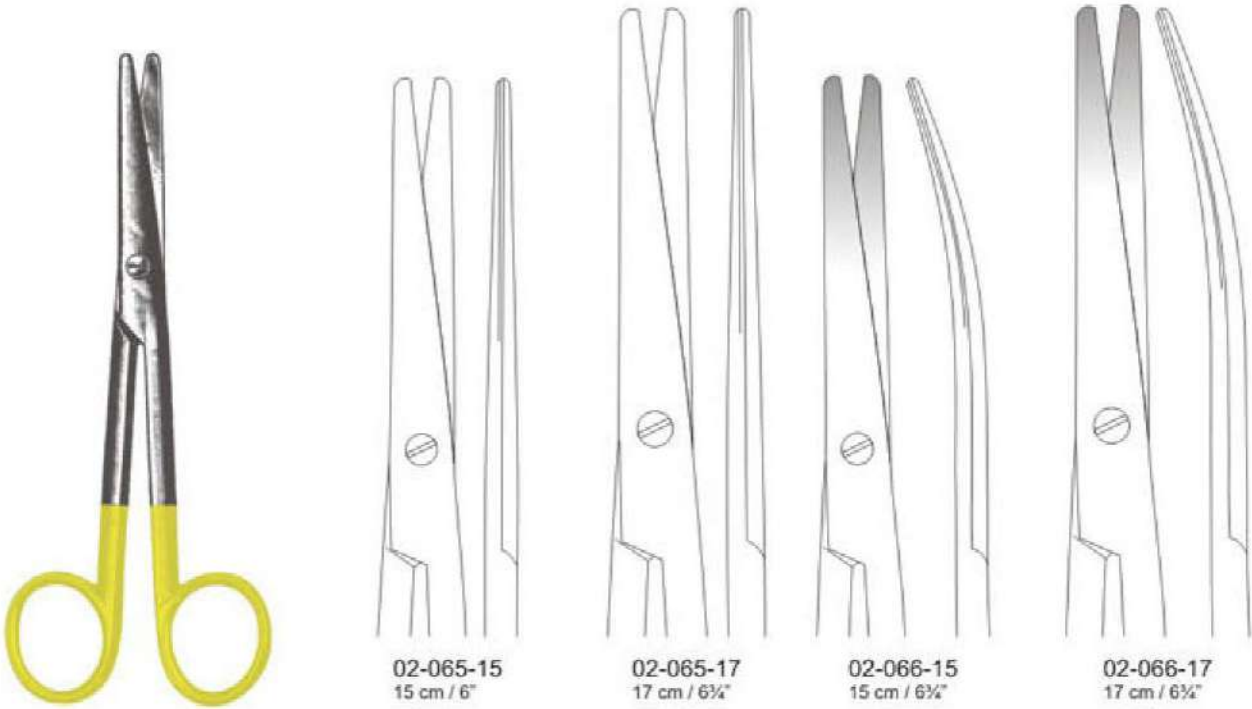

02-065-15	02-065-17	02-066-15	02-066-17
15 cm / 6"	17 cm / 6¾"	15 cm / 6¾"	17 cm / 6¾"

Mayo-Stille TC
02-065-15 - 02-066-17



TUNGSTEN CARBIDE SCISSORS

Operating Scissors



Mayo-Noble TC
02-067-17 - 02-068-17
17 cm / 6 3/4"

1/1



02-067-17
Str.

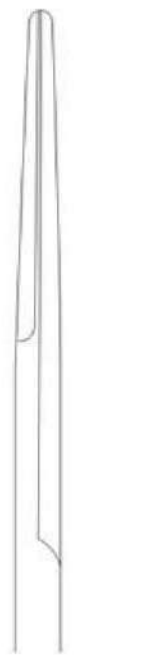

02-068-17
Cvd.

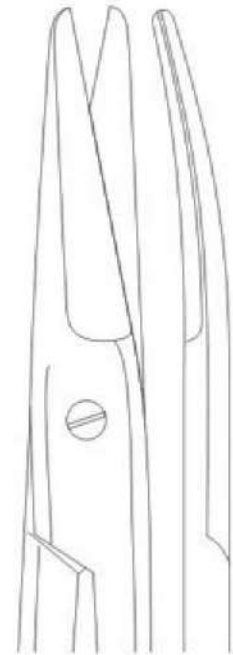

Kelly TC
02-069-16 - 02-070-18

1/1



02-069-16
16 cm / 6 1/2"

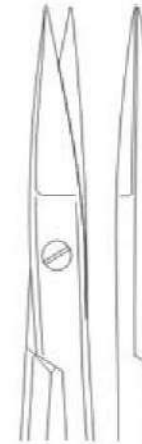

02-070-18
18 cm / 7 1/4"



Baby Metzenbaum TC
02-071-11 - 02-072-11
11.5 cm / 4 1/2"



02-071-11



02-072-11

TUNGSTEN CARBIDE SCISSORS

Operating Scissors

Inches



Metzenbaum TC
02-073-14 - 02-078-14

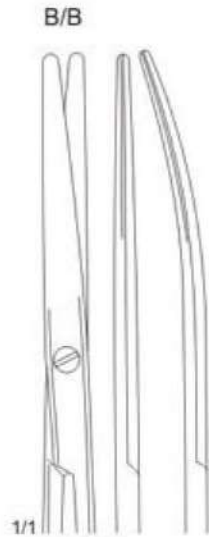

- 1/1
- | | | |
|-----------|-------------|-----|
| 02-073-14 | 14 cm / 5½" | str |
| 02-074-14 | 14 cm / 5½" | cvd |
| 02-073-15 | 15 cm / 6" | str |
| 02-074-15 | 15 cm / 6" | cvd |
| 02-073-18 | 18 cm / 7" | str |
| 02-074-18 | 18 cm / 7" | cvd |
| 02-073-20 | 20 cm / 8" | str |
| 02-074-20 | 20 cm / 8" | cvd |
| 02-073-23 | 23 cm / 9" | str |
| 02-074-23 | 23 cm / 9" | cvd |
| 02-073-25 | 25 cm / 10" | str |
| 02-074-25 | 25 cm / 10" | cvd |
| 02-073-28 | 28 cm / 11" | str |
| 02-074-28 | 28 cm / 11" | cvd |
| 02-073-30 | 30 cm / 12" | str |
| 02-074-30 | 30 cm / 12" | cvd |



- | | | |
|-----------|-------------|-----|
| 02-075-14 | 14 cm / 5½" | str |
| 02-076-14 | 14 cm / 5½" | cvd |
| 02-075-15 | 15 cm / 6" | str |
| 02-076-15 | 15 cm / 6" | cvd |
| 02-075-18 | 18 cm / 7" | str |
| 02-076-18 | 18 cm / 7" | cvd |
| 02-075-20 | 20 cm / 8" | str |
| 02-076-20 | 20 cm / 8" | cvd |
| 02-075-23 | 23 cm / 9" | str |
| 02-076-23 | 23 cm / 9" | cvd |
| 02-075-25 | 25 cm / 10" | str |
| 02-076-25 | 25 cm / 10" | cvd |
| 02-075-28 | 28 cm / 11" | str |
| 02-076-28 | 28 cm / 11" | cvd |
| 02-075-30 | 30 cm / 12" | str |
| 02-076-30 | 30 cm / 12" | cvd |

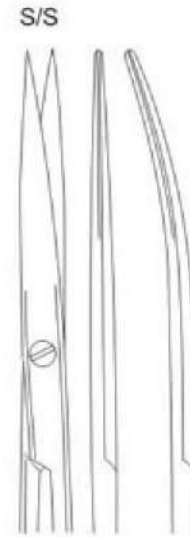

- | | | |
|-----------|-------------|-----|
| 02-077-14 | 14 cm / 5½" | str |
| 02-078-14 | 14 cm / 5½" | cvd |
| 02-077-15 | 15 cm / 6" | str |
| 02-078-15 | 15 cm / 6" | cvd |
| 02-077-18 | 18 cm / 7" | str |
| 02-078-18 | 18 cm / 7" | cvd |
| 02-077-20 | 20 cm / 8" | str |
| 02-078-20 | 20 cm / 8" | cvd |
| 02-077-23 | 23 cm / 9" | str |
| 02-078-23 | 23 cm / 9" | cvd |
| 02-077-25 | 25 cm / 10" | str |
| 02-078-25 | 25 cm / 10" | cvd |
| 02-077-28 | 28 cm / 11" | str |
| 02-078-28 | 28 cm / 11" | cvd |
| 02-077-30 | 30 cm / 12" | str |
| 02-078-30 | 30 cm / 12" | cvd |



Gorney TC
02-079-12 - 02-080-19

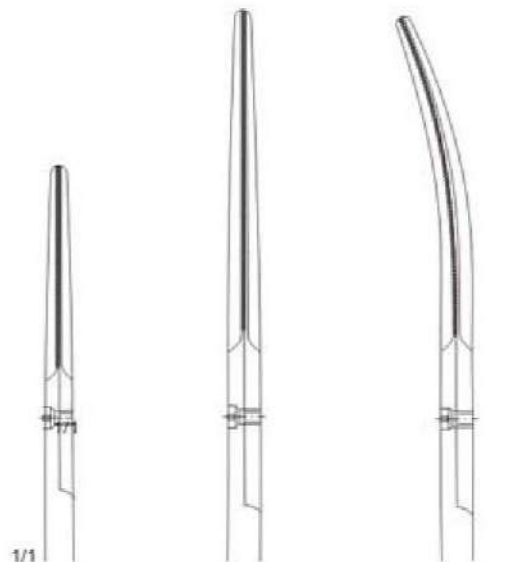

- 1/1
- | | | |
|-----------|---------------|------|
| 02-079-12 | 12.5 cm / 5" | Str. |
| 02-079-19 | 19.5 cm / 7¾" | Str. |
| 02-080-19 | 19.5 cm / 7¾" | Cvd. |



TUNGSTEN CARBIDE SCISSORS

Fine Operating Scissors



1/1
02-081-12
12 cm / 4 1/2"

02-081-15
15 cm / 6"

Kilner TC
02-081-12 - 02-081-15

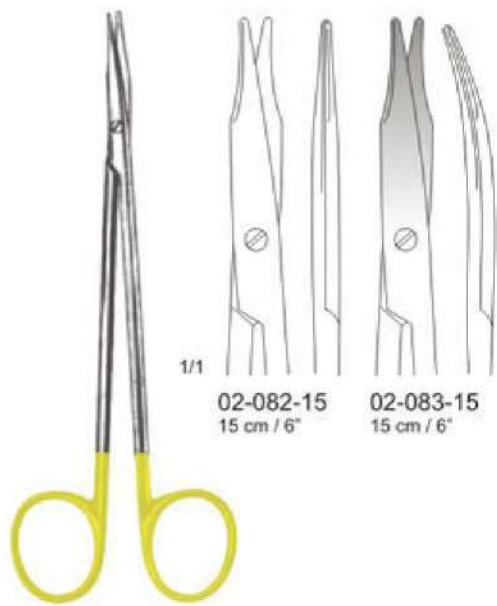

1/1
02-082-15
15 cm / 6"

02-083-15
15 cm / 6"

Reynolds TC
02-082-15 - 02-083-18



1/1

Fomon TC
02-084-15
15 cm / 6"



1/1

Cottle TC
02-085-16
16 cm / 8 1/2"

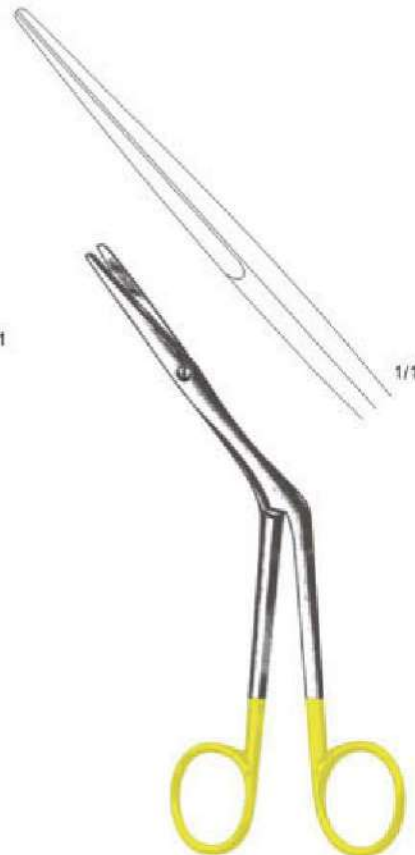

1/1

Heymann TC
02-086-18
18 cm / 7"

TUNGSTEN CARBIDE SCISSORS

Fine Operating Scissors

Inches



Iris TC
02-088-09 - 02-089-10

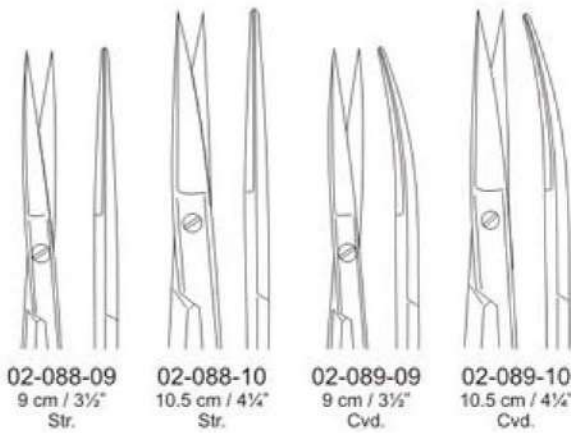

Strabismus TC
02-090-11 - 02-091-11
11.5 cm / 4½"

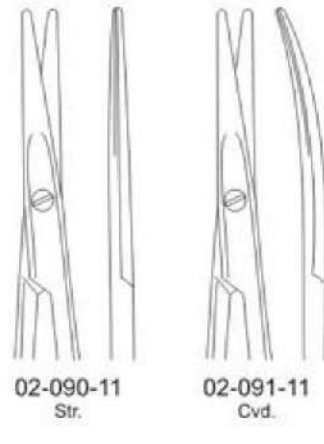

Iris
02-092-11 - 02-095-11
11.5 cm / 4½"

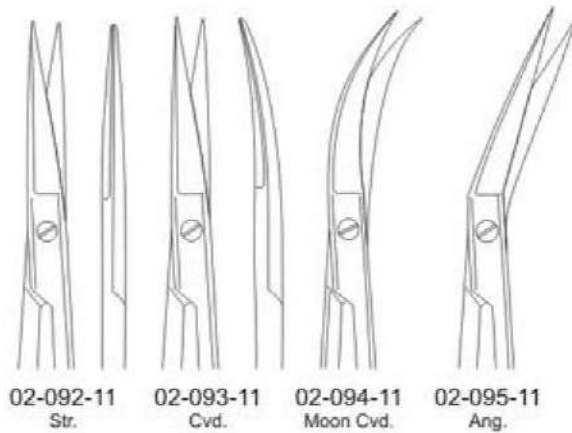

Wagner TC
02-096-12 - 02-097-12
12 cm / 4½"

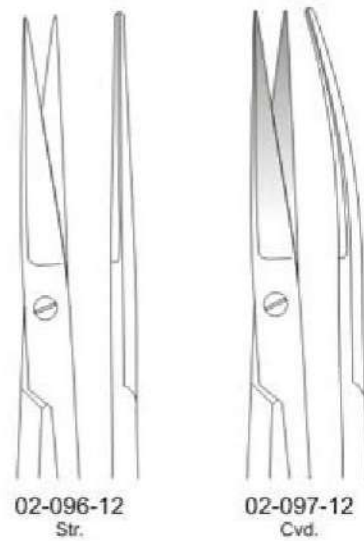

TUNGSTEN CARBIDE SCISSORS

Fine Operating Scissors



02-098-11



02-099-11



Btrabismus TC
02-090-11 - 02-091-11
11.5 cm / 4½"



02-100-11



02-101-11



Btrabismus TC
02-090-11 - 02-091-11
11.5 cm / 4½"

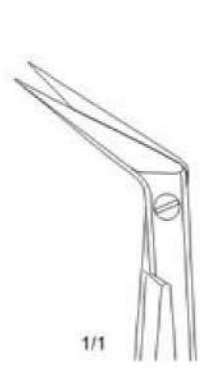

02-102-19
19 cm / 7½"

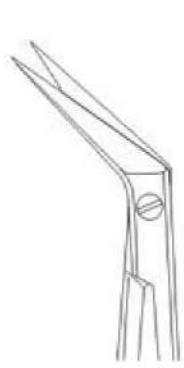

02-103-19
19 cm / 7½"



02-104-19
19 cm / 7½"



Jameson TC
02-105-15
15 cm / 6"



Jameson TC
02-106-13
13 cm / 5"



Dietrich TC
02-107-25 - 02-108-00



02-107-25
18 cm / 7"



02-107-45
18 cm / 7"



02-107-60
17.5 cm / 7"



02-107-90
17 cm / 6½"



02-108-00
17 cm / 6½"

TUNGSTEN CARBIDE SCISSORS

Gynecological Operating Scissors

Inches



Sims TC
02-109-19 - 02-110-19

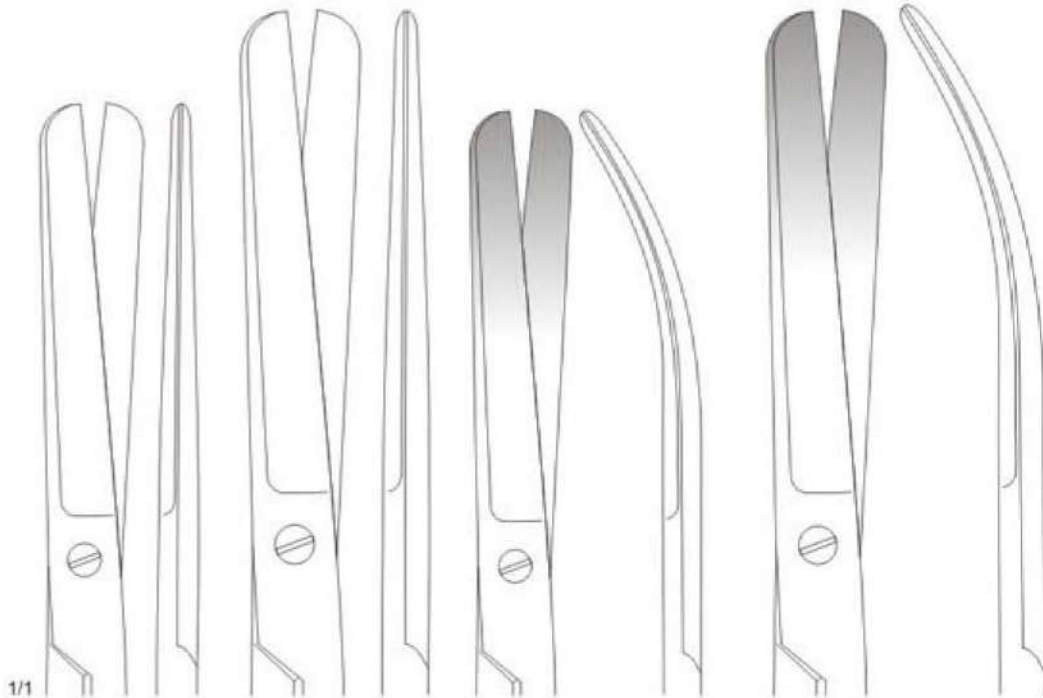

1/1
02-109-20
20 cm / 8"
Str.

02-109-23
23 cm / 9"
Str.

02-110-23
20 cm / 8"
Cvd.

02-110-23
23 cm / 9"
Cvd.



Doyen TC
02-111-17 - 02-112-17

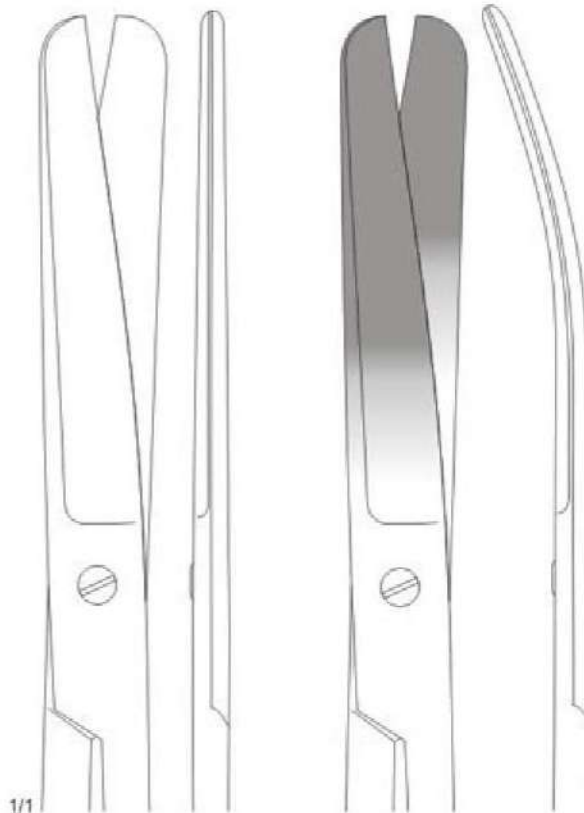

1/1
02-111-17
27.5 cm / 7"
Str.

02-112-17
27.5 cm / 7"
Cvd.



TUNGSTEN CARBIDE SCISSORS

Bandage & Plaster Scissors



Lister TC
02-113-09 9 cm / 3½"
02-113-14 14 cm / 5½"
02-113-18 18 cm / 7"
02-113-20 20 cm / 8"



Bergmann TC
02-114-23
23 cm / 9"

Esmarch TC
02-115-20 20 cm / 8"
02-116-22 22 cm / 8¾"



TUNGSTEN CARBIDE SCISSORS

Episiotomy Scissors

Inches



Braun-Standler TC
02-117-14
14.5 cm / 5 1/2"



Braun-Standler TC
02-118-22
22 cm / 8 1/2"



Busch TC
02-119-16
16 cm / 6 1/4"



Universal TC
02-120-12
12 cm / 4 1/2"





SUPER CUT SCISSORS

Operating Scissors



Standard SC (S/S, Str.)
02-121-11 - 02-124-16

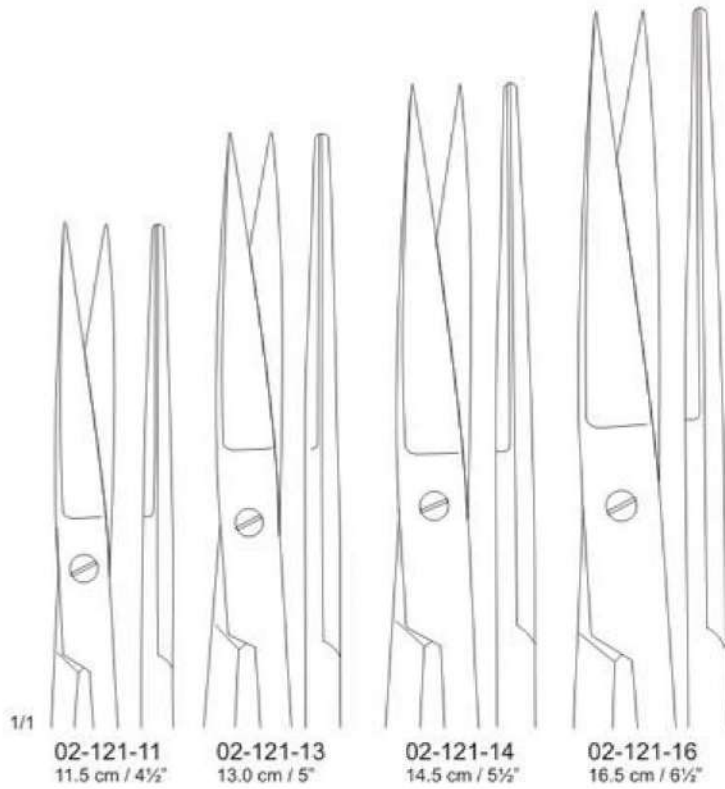

Standard SC (S/S, Cvd.)
02-122-11 - 02-122-16

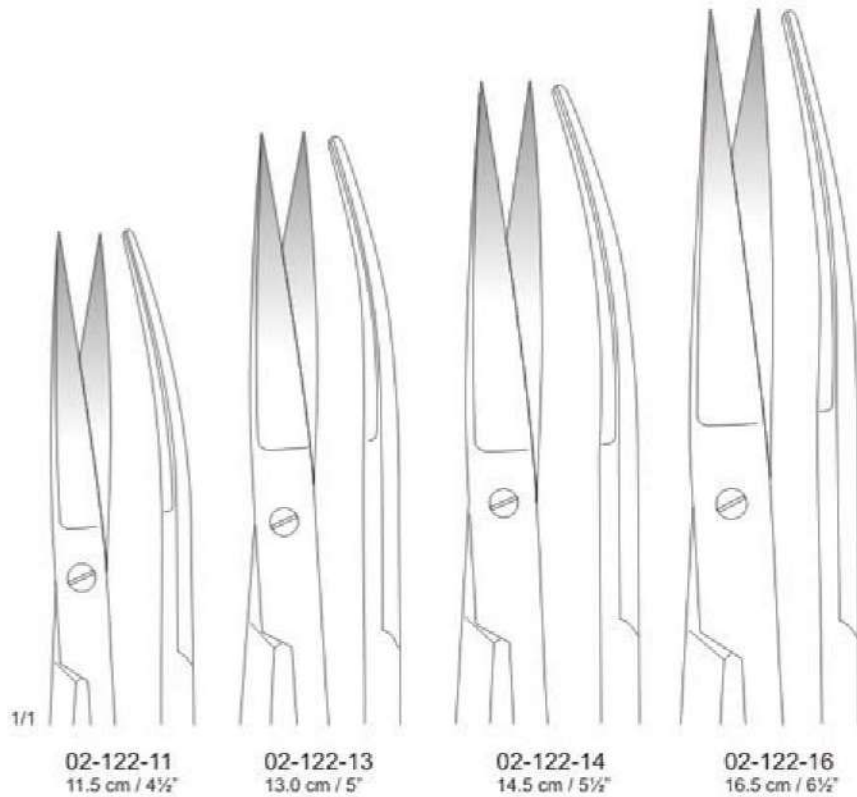

SUPER CUT SCISSORS

Operating Scissors

Inches



Standard SC (S/B, Str.)
02-123-11 - 02-123-18

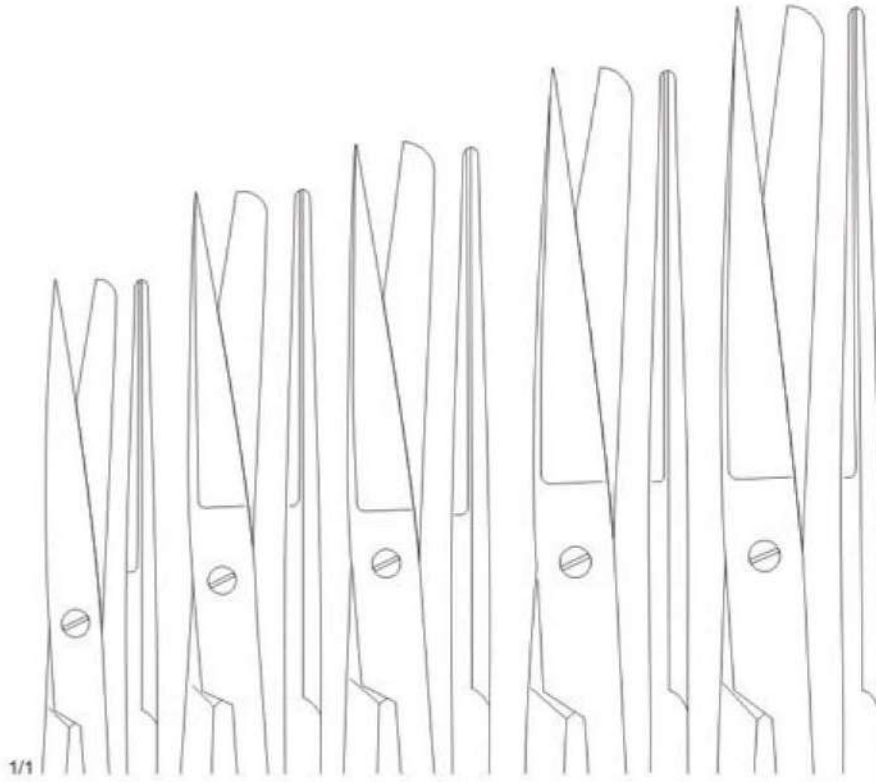

02-123-11
11.5 cm / 4½"

02-123-13
13.0 cm / 5½"

02-123-14
14.5 cm / 5¾"

02-123-16
16.5 cm / 6½"

02-123-18
18.5 cm / 7½"



Standard SC (S/B, Cvd.)
02-124-11 - 02-124-18

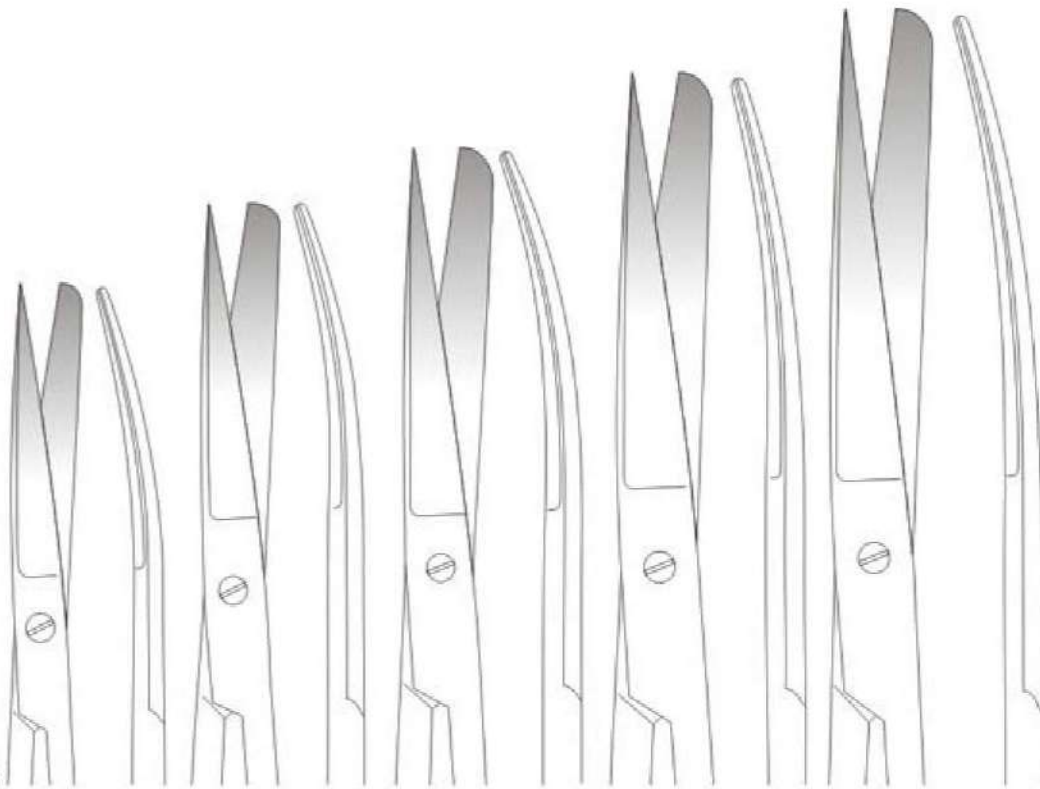

02-124-11
11.5 cm / 4½"

02-124-13
13.0 cm / 5½"

02-124-14
14.5 cm / 5¾"

02-124-16
16.5 cm / 6½"

02-124-18
18.5 cm / 7½"



SUPER CUT SCISSORS

Operating Scissors



Standard SC (B/B, Str.)
02-125-11 - 02-125-18

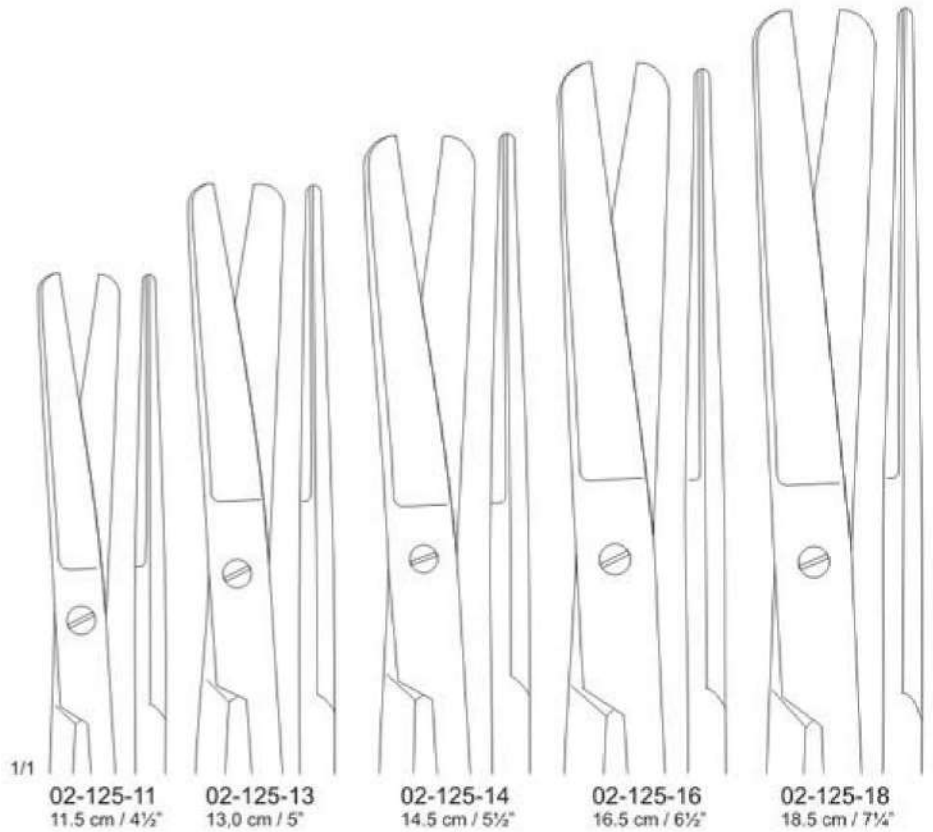

Standard SC (B/B, Cvd.)
02-126-11 - 02-126-18

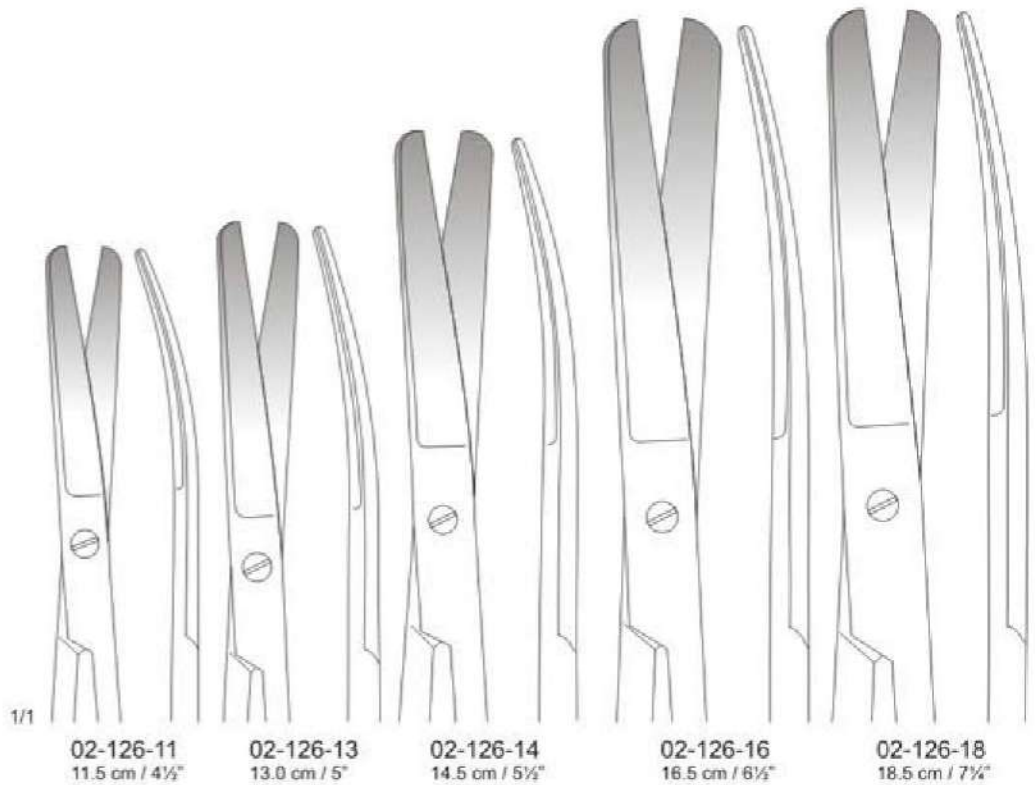

SUPER CUT SCISSORS

Operating Scissors

Inches

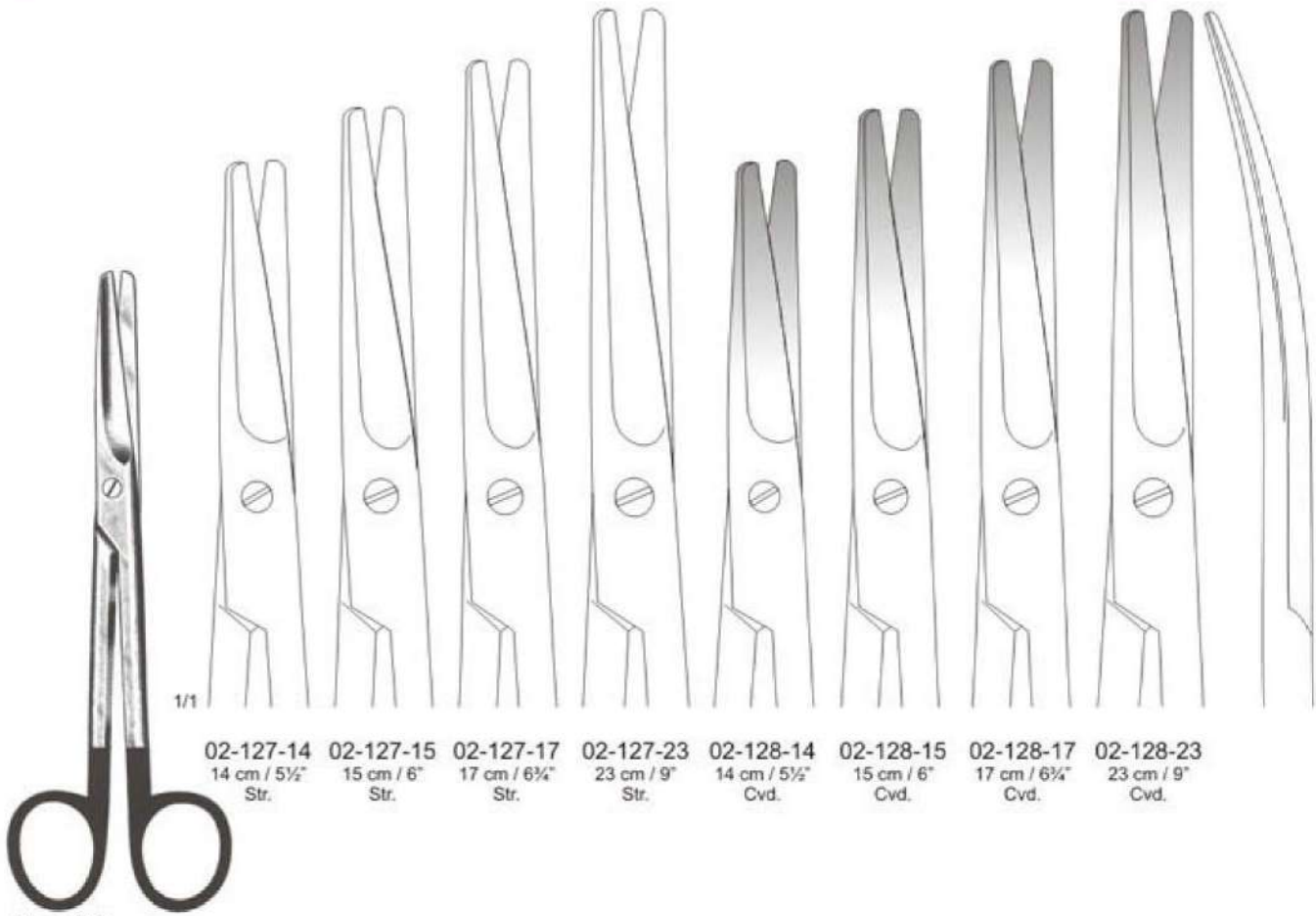

1/1

02-127-14
14 cm / 5½"
Str.

02-127-15
15 cm / 6"
Str.

02-127-17
17 cm / 6¾"
Str.

02-127-23
23 cm / 9"
Str.

02-128-14
14 cm / 5½"
Cvd.

02-128-15
15 cm / 6"
Cvd.

02-128-17
17 cm / 6¾"
Cvd.

02-128-23
23 cm / 9"
Cvd.

Mayo SC
02-127-14 - 02-128-23



1/1

02-129-15
15 cm / 6"
Str.

02-129-17
17 cm / 6¾"
Str.

02-130-15
15 cm / 6"
Cvd.

02-130-17
17 cm / 6¾"
Cvd.

Mayo-Stille SC
02-129-15 - 02-130-17



SUPER CUT SCISSORS

Operating Scissors



Mayo-Noble SC
02-131-17 - 02-132-17
17 cm / 6 3/4"



02-131-17
Str.



02-132-17
Cvd.

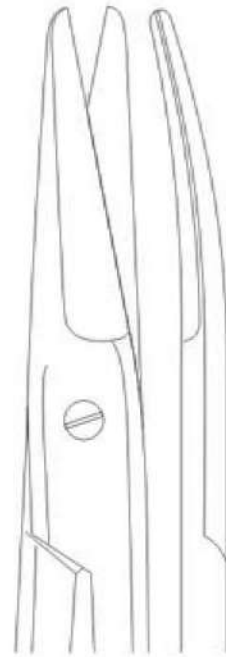

Kelly SC
02-133-16 - 02-134-18

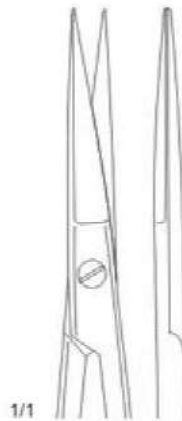

02-133-16
16 cm / 6 1/2"
Str.



02-134-16
16 cm / 6 1/2"
Cvd.



Baby Metzenbaum SC
02-135-11 - 02-136-11
11,5 cm / 4 1/2"



02-135-11
Str.



02-136-11
Cvd.



Metzenbaum SC
02-137-14 - 02-142-14

B/B

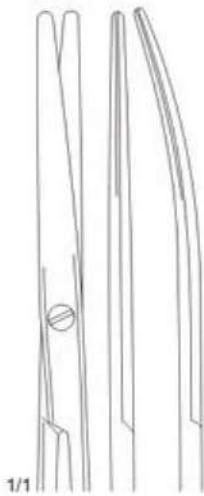

- 02-137-14 14 cm / 5½" str
- 02-138-14 14 cm / 5½" cvd
- 02-137-15 15 cm / 6" str
- 02-138-15 15 cm / 6" cvd
- 02-137-18 18 cm / 7" str
- 02-138-18 18 cm / 7" cvd
- 02-137-20 20 cm / 8" str
- 02-138-20 20 cm / 8" cvd
- 02-137-23 23 cm / 9" str
- 02-138-23 23 cm / 9" cvd
- 02-137-25 25 cm / 10" str
- 02-138-25 25 cm / 10" cvd
- 02-137-28 28 cm / 11" str
- 02-138-28 28 cm / 11" cvd
- 02-137-30 30 cm / 12" str
- 02-138-30 30 cm / 12" cvd

S/B

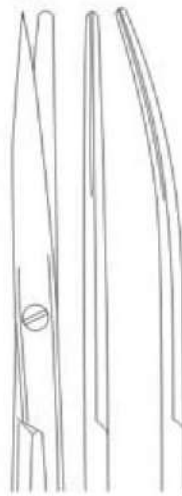

- 02-139-14 14 cm / 5½" str
- 02-140-14 14 cm / 5½" cvd
- 02-139-15 15 cm / 6" str
- 02-140-15 15 cm / 6" cvd
- 02-139-18 18 cm / 7" str
- 02-140-18 18 cm / 7" cvd
- 02-139-20 20 cm / 8" str
- 02-140-20 20 cm / 8" cvd
- 02-139-23 23 cm / 9" str
- 02-140-23 23 cm / 9" cvd
- 02-139-25 25 cm / 10" str
- 02-140-25 25 cm / 10" cvd
- 02-139-28 28 cm / 11" str
- 02-140-28 28 cm / 11" cvd
- 02-139-30 30 cm / 12" str
- 02-140-30 30 cm / 12" cvd

S/S

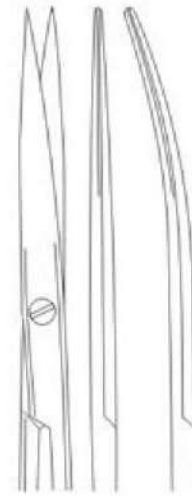

- 02-141-14 14 cm / 5½" str
- 02-142-14 14 cm / 5½" cvd
- 02-141-15 15 cm / 6" str
- 02-142-15 15 cm / 6" cvd
- 02-141-18 18 cm / 7" str
- 02-142-18 18 cm / 7" cvd
- 02-141-20 20 cm / 8" str
- 02-142-20 20 cm / 8" cvd
- 02-141-23 23 cm / 9" str
- 02-142-23 23 cm / 9" cvd
- 02-141-25 25 cm / 10" str
- 02-142-25 25 cm / 10" cvd
- 02-141-28 28 cm / 11" str
- 02-142-28 28 cm / 11" cvd
- 02-141-30 30 cm / 12" str
- 02-142-30 30 cm / 12" cvd



Gorney SC
02-143-12 - 02-144-19



02-143-12
12,5 cm / 5"



02-143-19
19,5 cm / 7¾"



02-144-19
19,5 cm / 7¾"



SUPER CUT SCISSORS

Fine Operating Scissors



Kilner SC
02-145-12 - 02-046-18

1/1

02-145-12
12 cm / 4½"

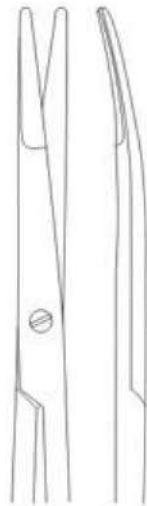

02-146-15
15 cm / 6"



Reynolds SC
02-147-15 - 02-148-18

1/1

02-147-15
15 cm / 6"

02-148-15
15 cm / 6"



Fomon SC
02-149-15
15 cm / 6"



Cottle SC
02-150-16
16 cm / 6½"



Heymann SC
02-151-18
18 cm / 7"



SUPER CUT SCISSORS

Fine Operating Scissors

Inches

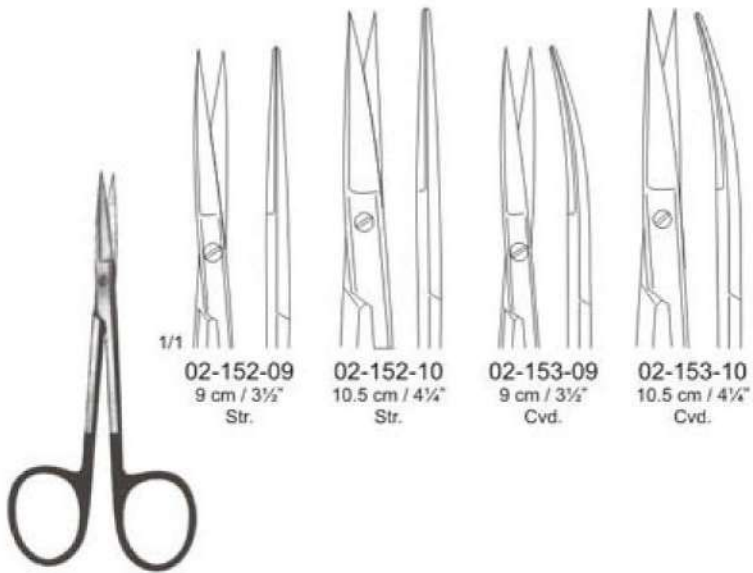

Iris SC
02-152-09 - 02-153-10

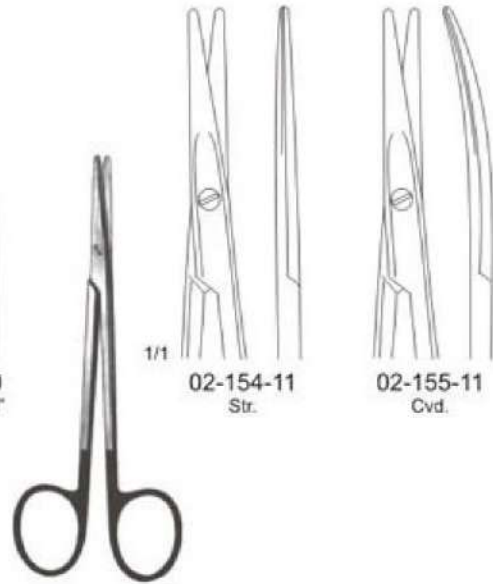

Strabismus SC
02-154-11 - 02-155-11
11.5 cm / 4 1/2"

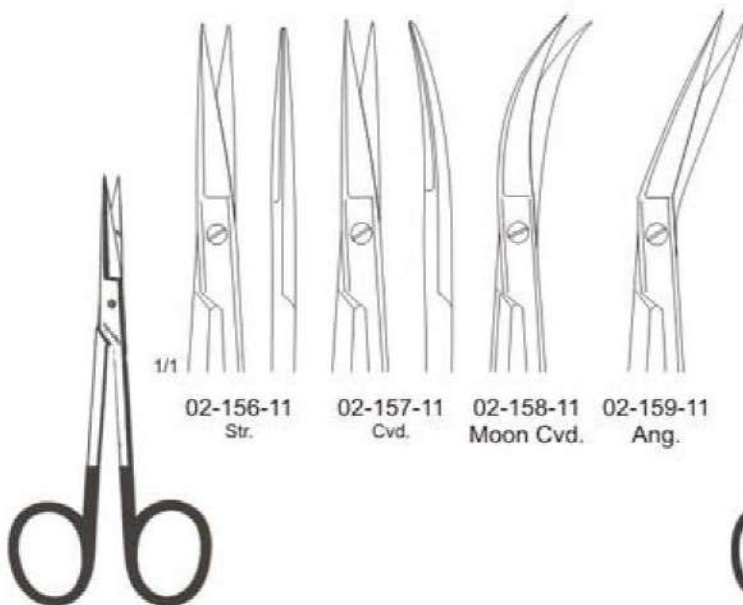

Iris SC
02-156-11 - 02-159-11
11.5 cm / 4 1/2"

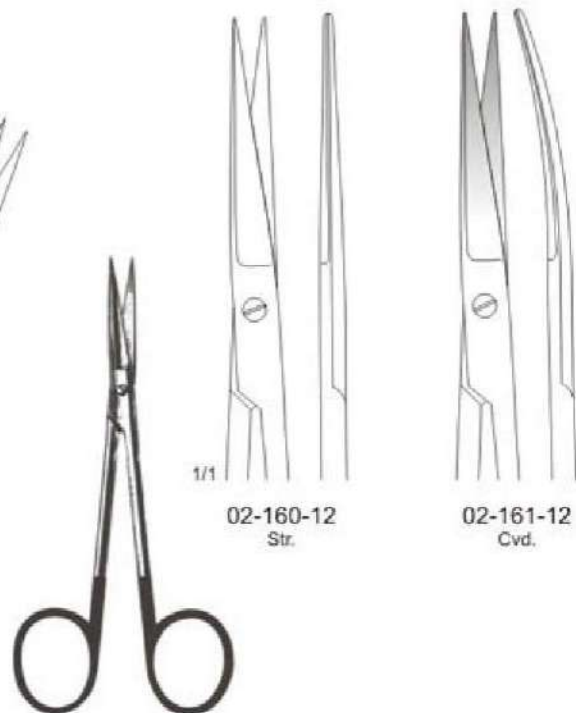

Wagner SC
02-160-12 - 02-161-12
12 cm / 4 3/4"

SUPER CUT SCISSORS

Fine Operating Scissors



Potts-Smith SC
02-162-19 - 02-164-19
19 cm / 7½"

1/1

02-162-19
19 cm / 7½"

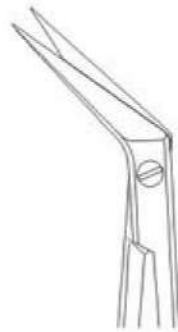

02-163-19
19 cm / 7½"



02-164-19
19 cm / 7½"



Jameson SC
02-165-15
15 cm / 6"

1/1



Jameson
02-166-13
13 cm / 5"

1/1



Dietrich SC
02-167-25 - 02-168-00



02-167-25
18 cm / 7"



02-167-45
18 cm / 7"



02-167-60
17.5 cm / 7"

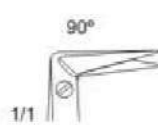

02-167-90
17 cm / 6¾"



02-168-00
17 cm / 6¾"



SUPER CUT SCISSORS

Gynecological & Operating Scissors

Inches



Sims SC
02-169-20 - 02-170-23

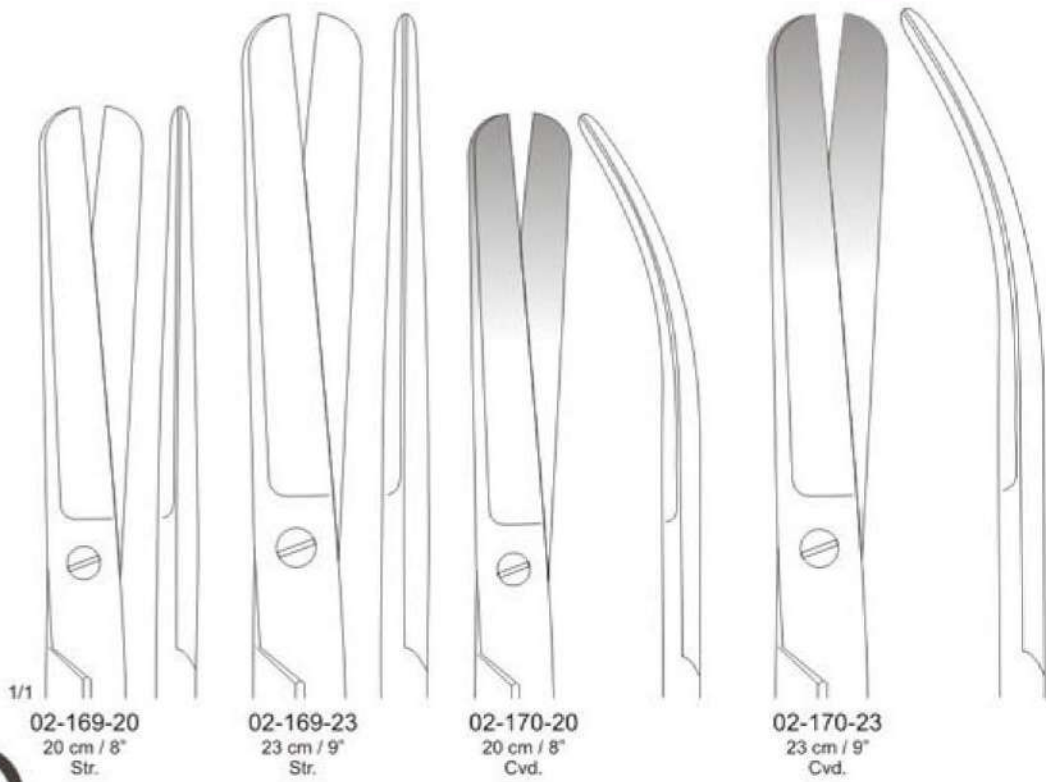

Braun-Standler TC
02-117-14
14.5 cm / 5½"

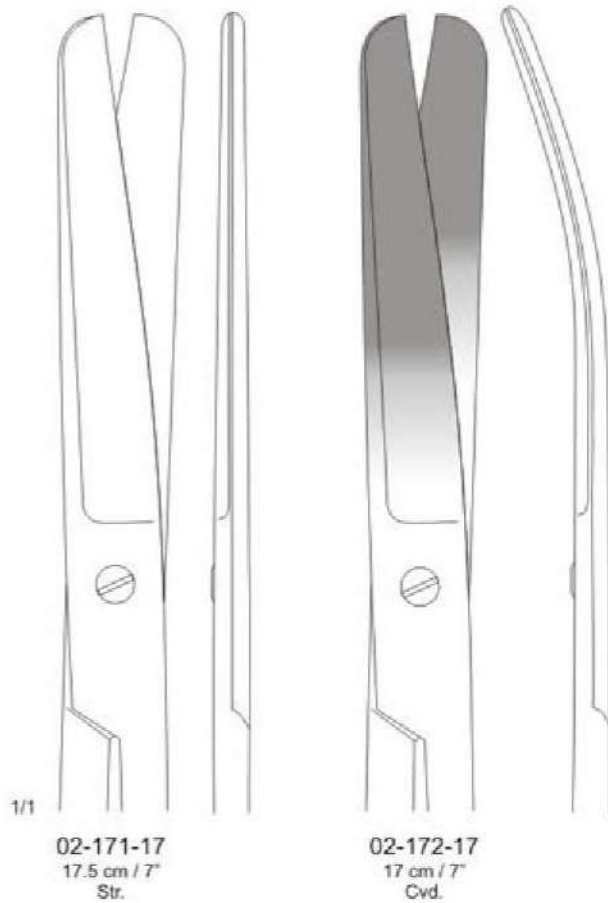

SUPER CUT SCISSORS

Bandage & Plaster Scissors



Lister SC
 02-173-09 09 cm / 3½"
 02-173-14 14 cm / 5½"
 02-173-18 18 cm / 7"
 02-173-20 20 cm / 8"

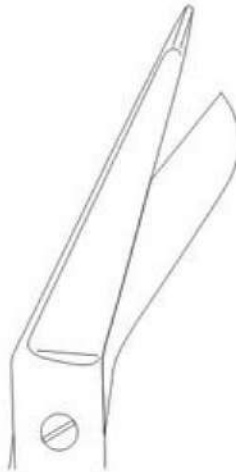

Busch SC
 02-174-16
 16 cm / 6¼"



Bergmann SC
 02-175-23
 23 cm / 9"

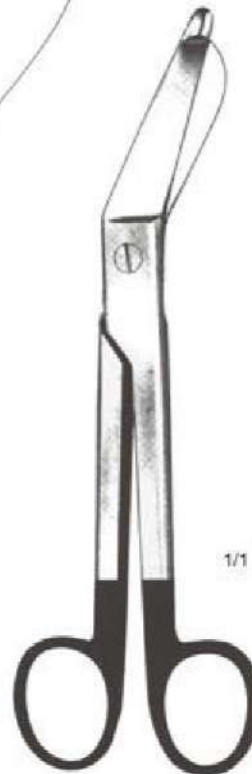
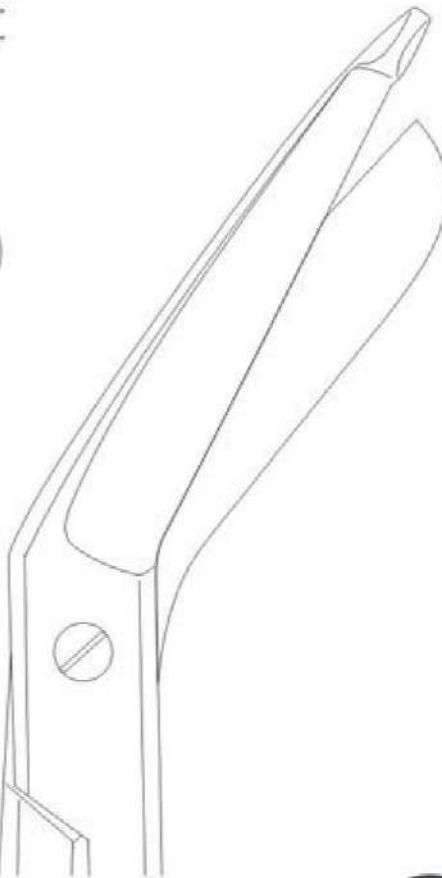

Esmarch SC
 02-176-20 20 cm / 8"
 02-176-22 22 cm / 8¾"

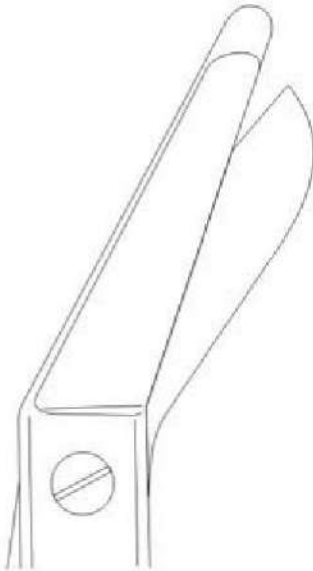

NEEDLE HOLDERS

03



FIVE S SURGICAL

Needle Holders

FORCEPS & CLAMPS

Hamostatic Forceps

Inches

Forceps Name	Part Numbers	Dimensions
Hartmann	03-001-10 - 03-002-10	10 cm / 4"
Halsted-Mosquito	03-003-12 - 03-006-14	12.5 cm / 5" - 14 cm / 5½"
Micro-Mosquito	03-007-10 - 03-010-12	10 cm / 4" - 12 cm / 4¾"
Baby-Mixer	03-011-01 - 03-011-02	14 cm / 5½"

FORCEPS & CLAMPS

Artery Forceps



Kelly
03-012-14 - 03-015-16



1/1
03-012-14
14 cm / 5½"



03-013-14
14 cm / 5½"



03-014-16
16 cm / 6¼"



03-015-16
16 cm / 6¼"



Crile
03-016-64 - 03-017-64
14 cm / 5½"



1/1
03-016-14



03-017-14



Crile-Rankin
03-018-16 - 03-019-16
16 cm / 6¼"



1/1
03-018-16



03-019-16



Dandy
03-020-16 - 03-021-16

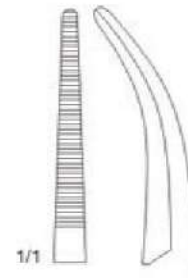

1/1
03-020-16

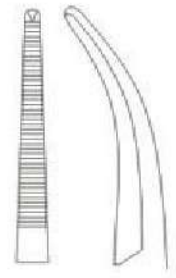

03-021-16
1x2 Teeth





Rochester Carmalt
03-022-16 - 03-023-20

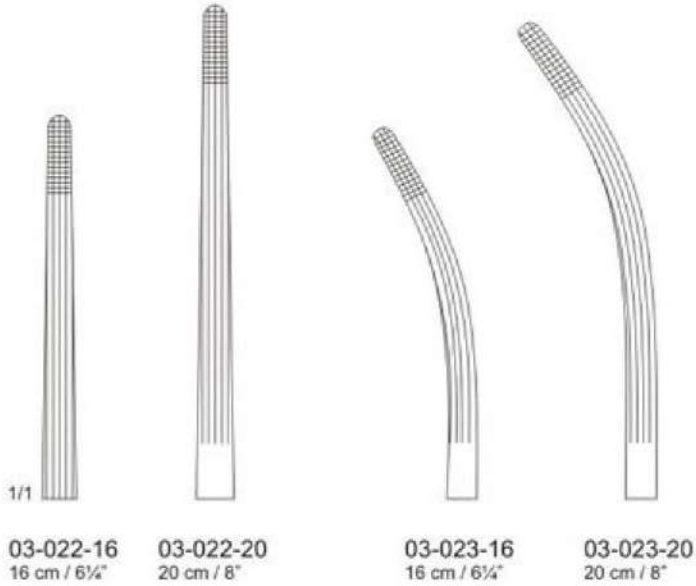

Schmidt
03-024-18 - 03-024-19

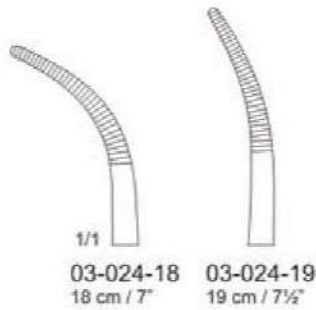

Adson
03-025-18 - 03-026-18
18.5 cm / 7 1/4"

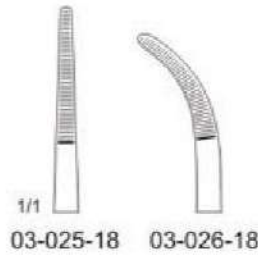

Mixer Baby
03-027-14
14 cm / 5 1/2"



FORCEPS & CLAMPS

Artery Forceps



Péan (Delicate)
03-028-13 - 03-029-16

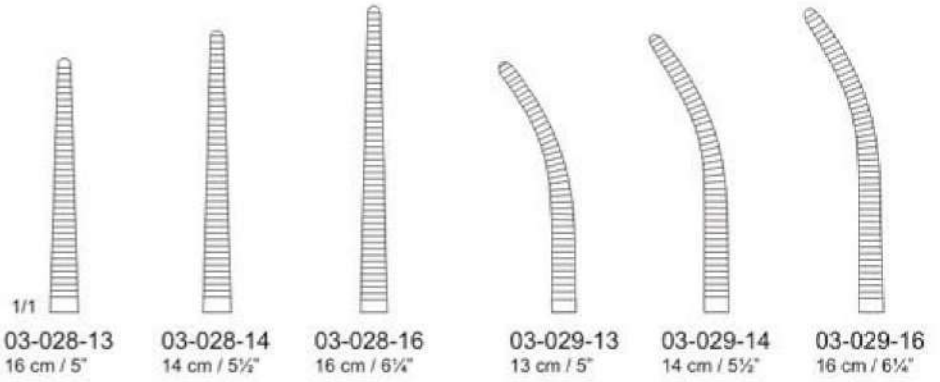

Péan
03-030-13 - 03-031-16

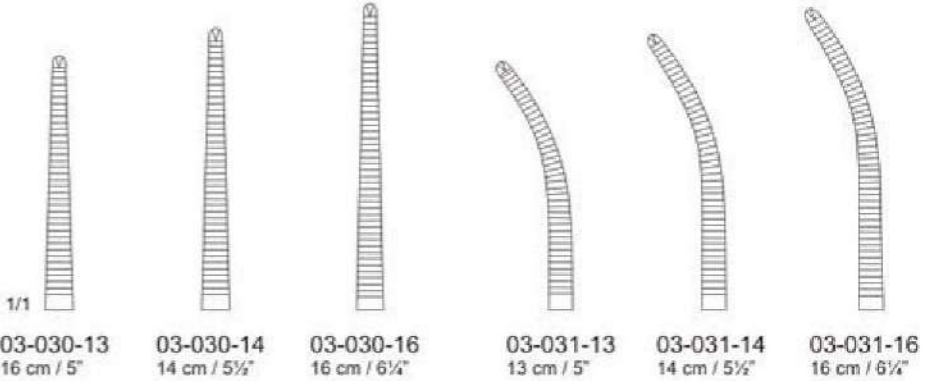

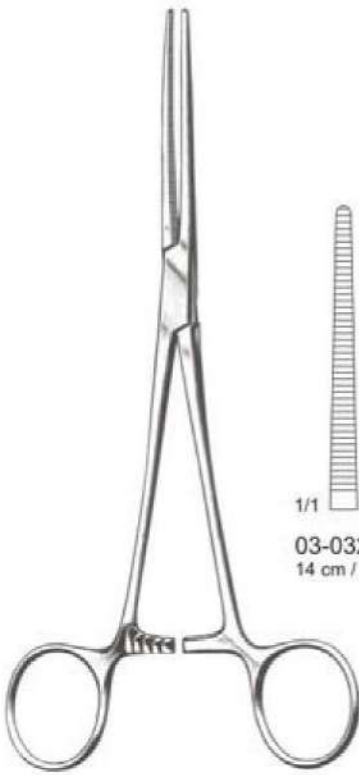

Péan (Rochester)
03-032-14 - 03-033-30

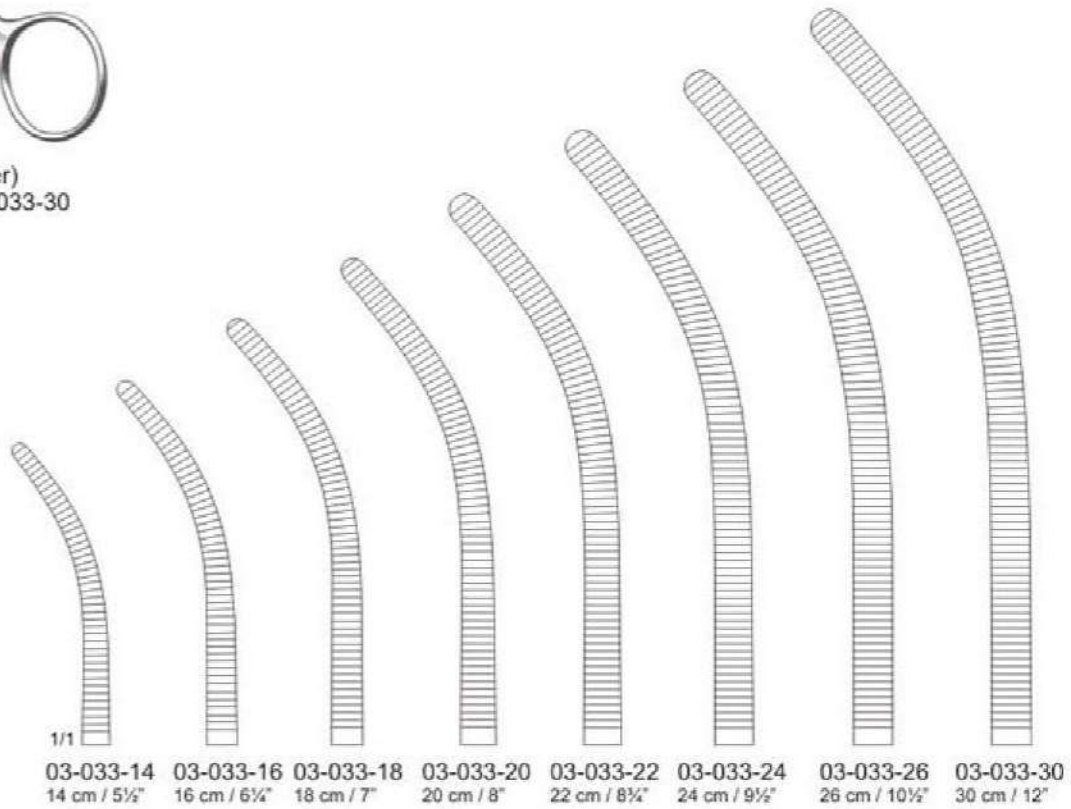
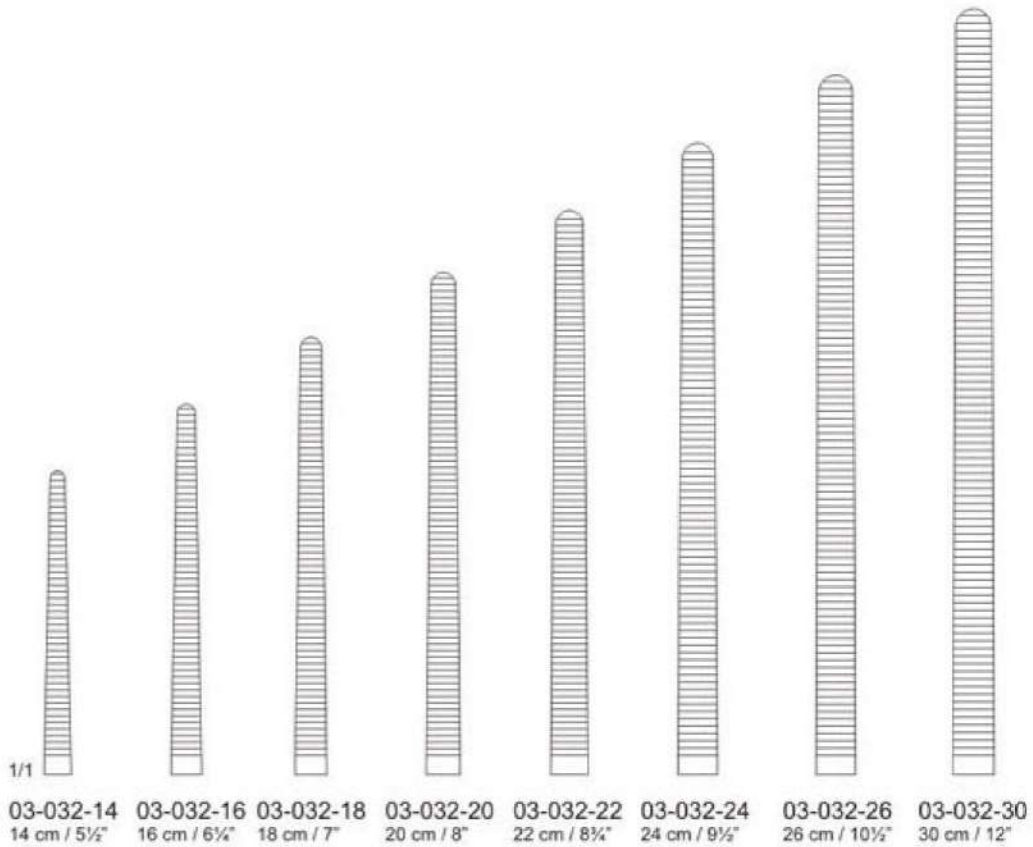

FORCEPS & CLAMPS

Artery Forceps

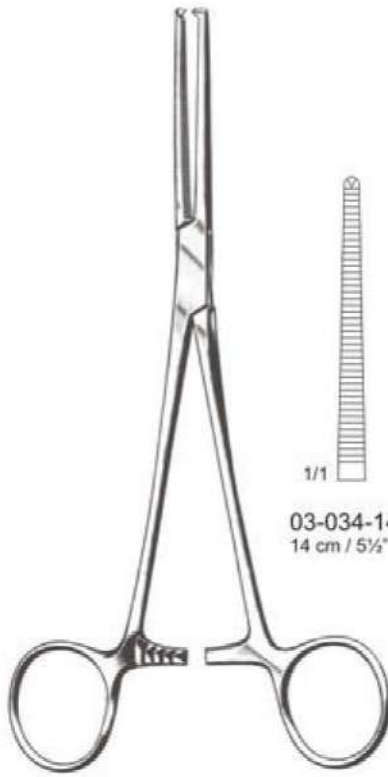

Kocher (Ochsner)
03-034-14 - 03-035-30

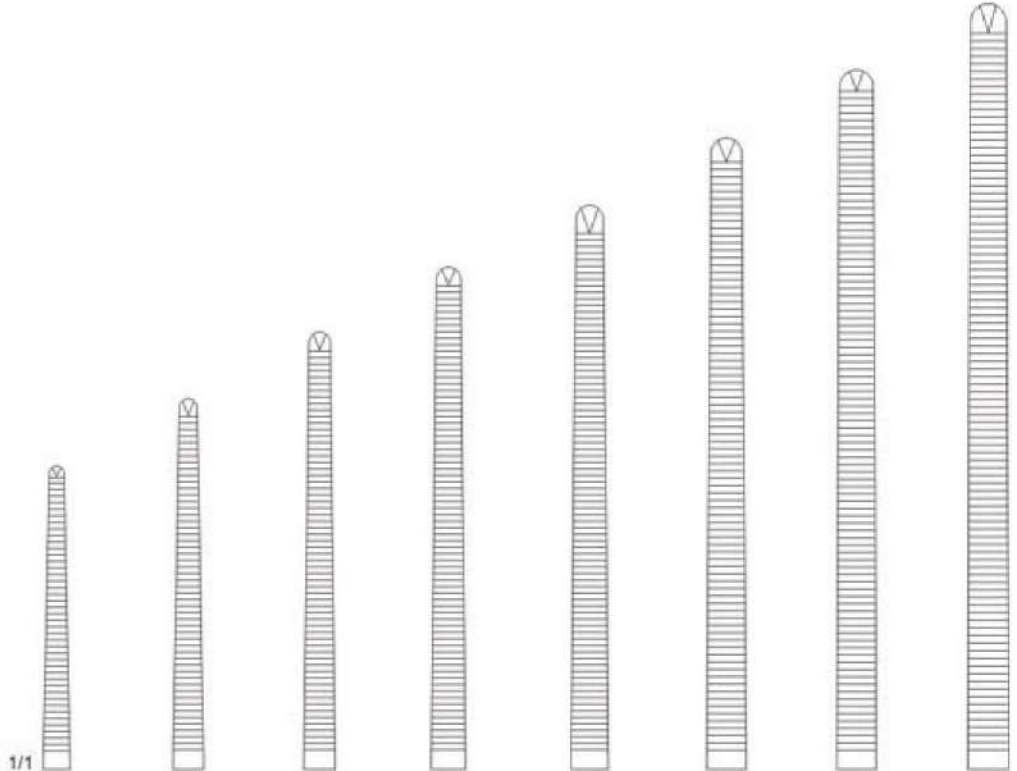

- 03-034-14 14 cm / 5½"
- 03-034-16 16 cm / 6¼"
- 03-034-18 18 cm / 7"
- 03-034-20 20 cm / 8"
- 03-034-22 22 cm / 8¾"
- 03-034-24 24 cm / 9½"
- 03-034-26 26 cm / 10½"
- 03-034-30 30 cm / 12"

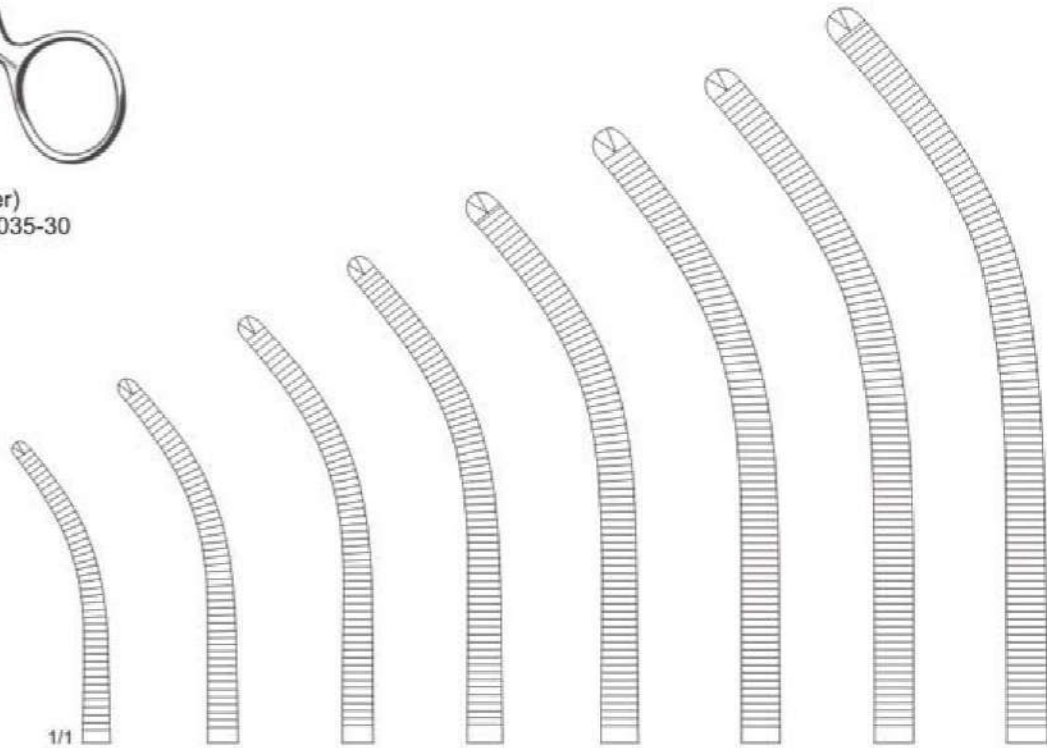

- 03-035-14 14 cm / 5½"
- 03-035-16 16 cm / 6¼"
- 03-035-18 18 cm / 7"
- 03-035-20 20 cm / 8"
- 03-035-22 22 cm / 8¾"
- 03-035-24 24 cm / 9½"
- 03-035-26 26 cm / 10½"
- 03-035-30 30 cm / 12"





FORCEPS & CLAMPS

Polypus, Tumor, Swab Forceps

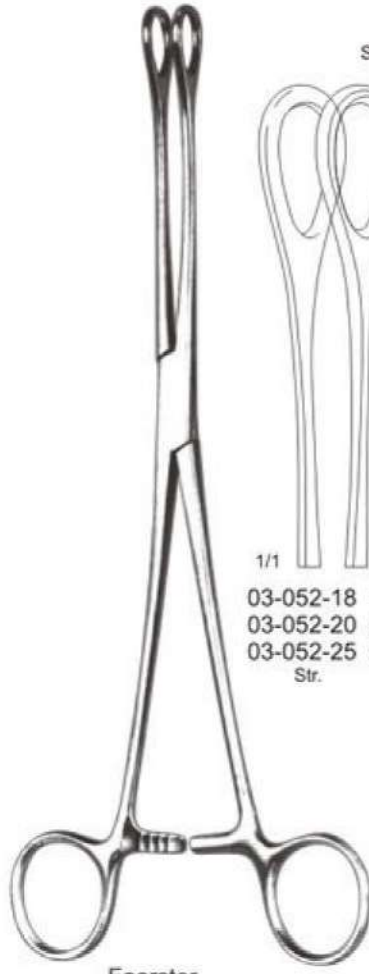

Foerster
03-052-18 - 03-055-25

SMOOTH

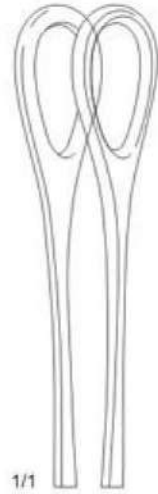

1/1
03-052-18 18 cm / 7"
03-052-20 20 cm / 8"
03-052-25 25 cm / 10"
Str.

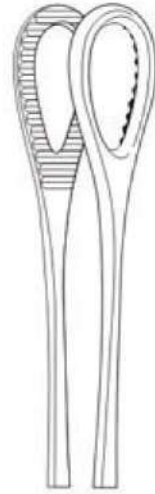

03-053-18 18 cm / 7"
03-053-20 20 cm / 8"
03-053-25 25 cm / 10"
Str.

SMOOTH

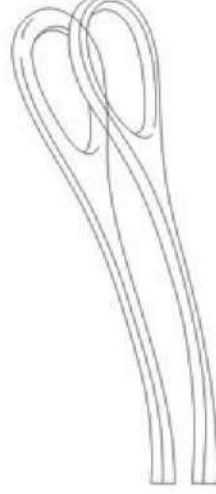

03-054-18 18 cm / 7"
03-054-20 20 cm / 8"
03-054-25 25 cm / 10"
Cvd.

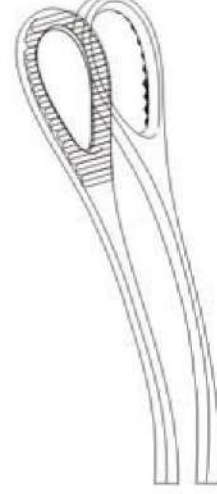

03-055-18 18 cm / 7"
03-055-20 20 cm / 8"
03-055-25 25 cm / 10"
Cvd.



Staude-Moore
03-056-17
17 cm / 6 3/4"



Rampléy
03-057-25
25 cm / 10"



1/1

FORCEPS & CLAMPS

Gynecological Forceps

Inches



03-080-16
16 cm / 6 1/4"

03-080-20
20 cm / 8 1/4"

03-080-25
25 cm / 10"

03-080-30
30 cm / 12"

Allis-DeBakey
03-080-16 - 03-080-30

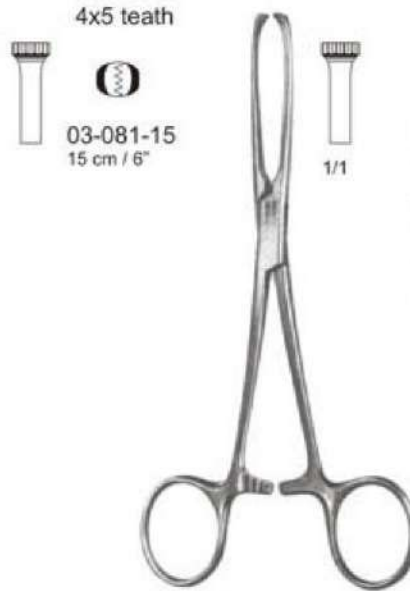

4x5 teeth

03-081-15
15 cm / 6"

5x6 teeth

03-082-15
15 cm / 6"

03-082-19
19 cm / 7 1/2"

03-082-25
25 cm / 10"

Allis
03-081-15 - 03-082-25



1/1

1/2

Judd-Allis
03-083-15 15 cm / 6"
03-083-19 19 cm / 7 1/2"



1/1

1/2

Allis-Adair
03-084-15
15 cm / 6"



1/1

1/2

Thomas-Allis
03-085-20
20 cm / 8"

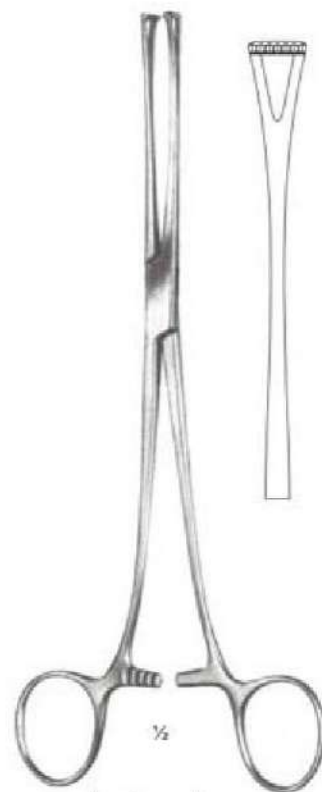

1/2

Lockwood
03-086-20
20 cm / 8"



0.

FORCEPS & CLAMPS

Tissue Forceps



Babcock
03-087-16 - 03-087-24



1/1
03-087-16
16 cm / 6 1/4"



03-087-18
18 cm / 7"



03-087-20
20 cm / 8"



03-087-24
24 cm / 9 1/2"

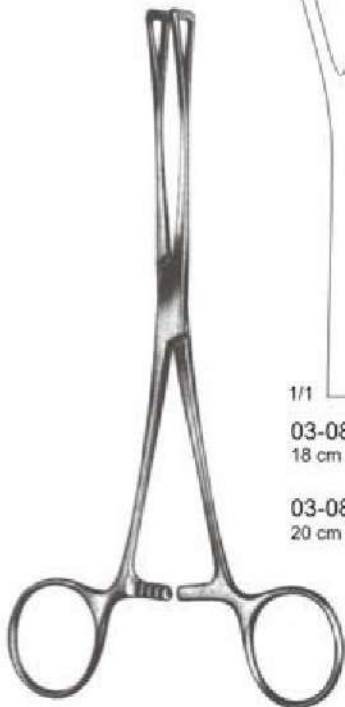

Duval
03-088-18 - 03-089-23



1/1
03-088-18
18 cm / 7"

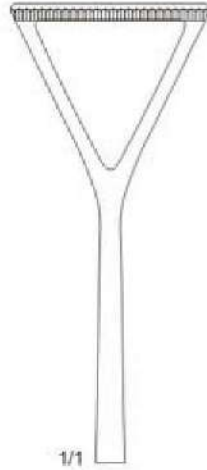

1/1
03-089-20
20 cm / 9"

03-088-20
20 cm / 8"

03-089-23
23 cm / 9"



1/1
03-090-18



03-091-18

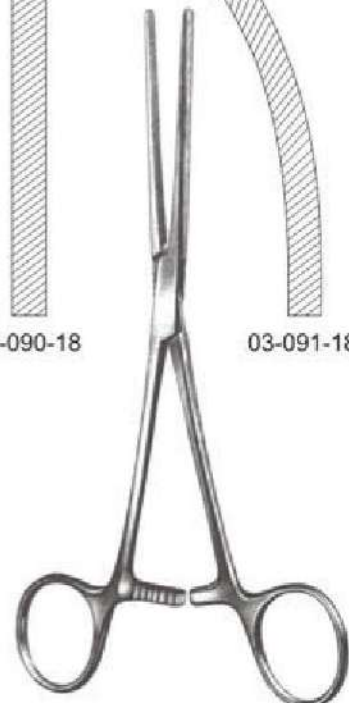

Baby-Doyen
03-090-18 - 03-091-18
18 cm / 7"



DeBaquey
03-108-05
05 cm / 2"



DeBaquey
03-109-05
05 cm / 2"



Glover
03-110-06
06 cm / 2½"



DeBaquey
03-111-06
06 cm / 2½"



DeBaquey
03-112-10
10 cm / 4"



DeBaquey
03-112-09
09 cm / 3½"



Glover
03-113-06 06 cm / 2½"
03-114-09 09 cm / 3½"
03-115-11 11 cm / 4½"



Cooley
03-116-06 06 cm / 3¼"
03-117-08 08 cm / 3½"
03-118-13 13 cm / 5½"



DeBaquey
03-119-08 08 cm / 3¼"
03-120-09 08 cm / 3½"
03-121-10 10 cm / 5¼"
03-122-13 13 cm / 4½"



DeBaquey
03-123-08 08 cm / 3¼"
03-124-09 08 cm / 3½"
03-125-10 10 cm / 3¾"
03-126-11 11 cm / 4½"



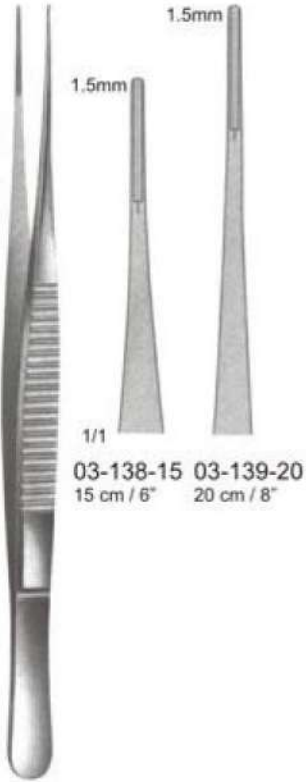

DeBakey
03-138-15 - 03-139-20

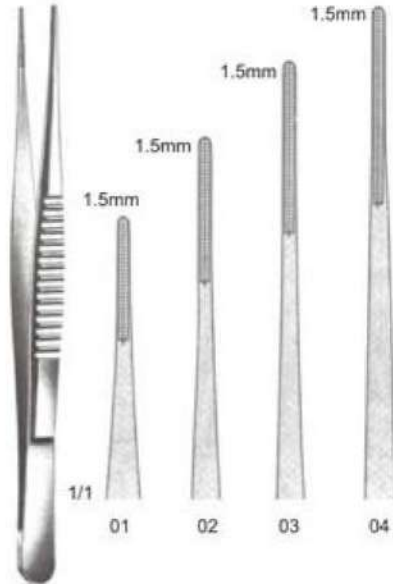

DeBakey
03-140-15 15 cm / 6" (01)
03-141-20 20 cm / 8" (02)
03-142-24 24 cm / 9½" (03)
03-143-30 30 cm / 12" (04)



DeBakey
03-144-15 15 cm / 6" (01)
03-145-20 20 cm / 8" (02)
03-146-24 24 cm / 9½" (03)
03-147-30 30 cm / 12" (04)

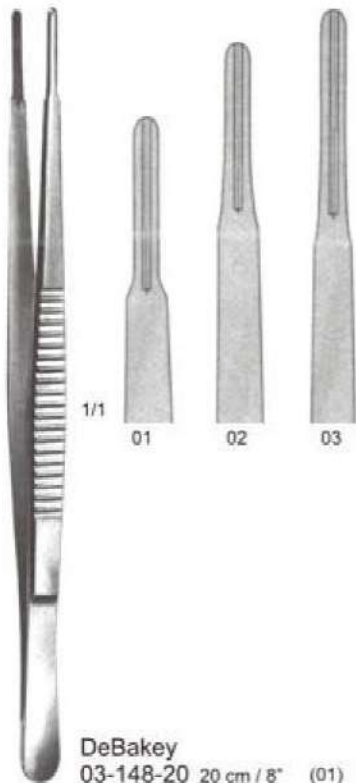

DeBakey
03-148-20 20 cm / 8" (01)
03-149-24 24 cm / 9½" (02)
3-150-30 30 cm / 12" (03)



DeBakey
03-151-15 15 cm / 6"



DeBakey
03-152-20 20 cm / 8"



NEEDLE HOLDERS

General Needle Holders



Derf
04-001-12 - 04-002-12



04-001-12
12 cm / 4 1/4"



Webster
04-003-13
13 cm / 5"



04-002-12
12.5 cm / 5"



Halsey
04-004-13
13 cm / 5"

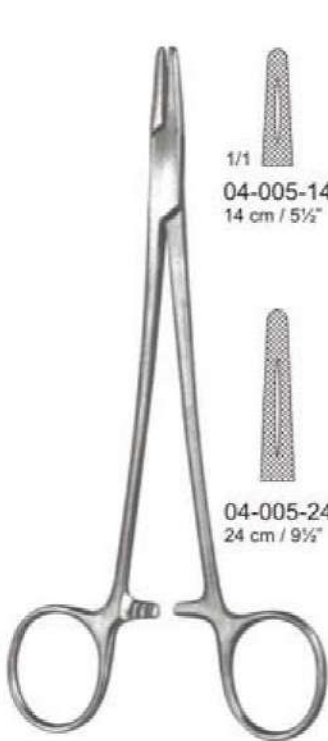

Mayo-Hegar
04-005-14 - 04-005-30



04-005-14
14 cm / 5 1/2"



04-005-16
16 cm / 6 1/4"



04-005-18
18 cm / 7"



04-005-20
20 cm / 8"



04-005-24
24 cm / 9 1/2"



04-005-26
26 cm / 10 1/4"



04-005-30
30 cm / 12"



Crile-Wood
15 cm / 6"



04-006-15

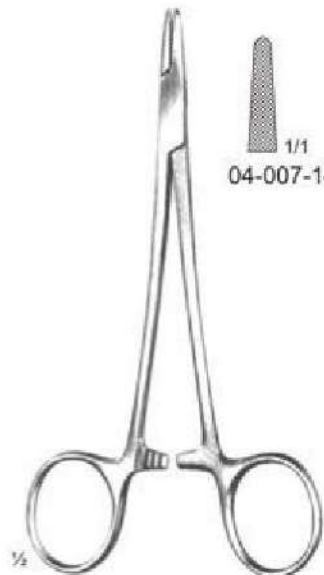

Hegar-Baumgartner
14 cm / 5 1/2"



04-007-14



NEEDLE HOLDERS

General Needle Holders

Inches



1/1

04-008-16
16 cm / 6 1/4"



04-008-18
18 cm / 7"



04-008-20
20 cm / 8"

Mayo-Hegar (Delicate)
04-008-16 - 04-008-20

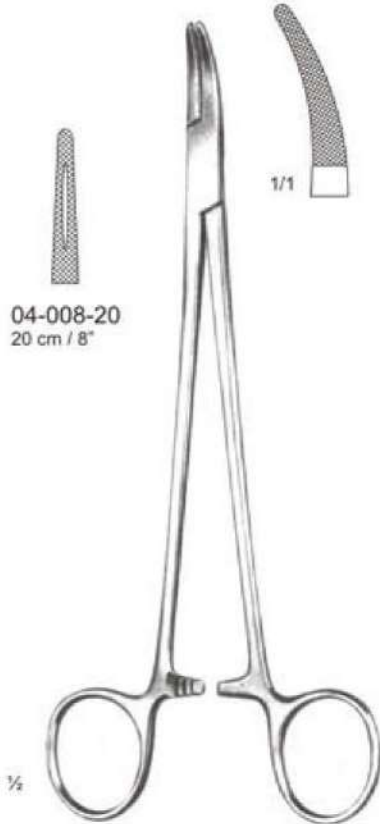

1/1

1/2

Heaney
04-009-21
21 cm / 8 1/4"

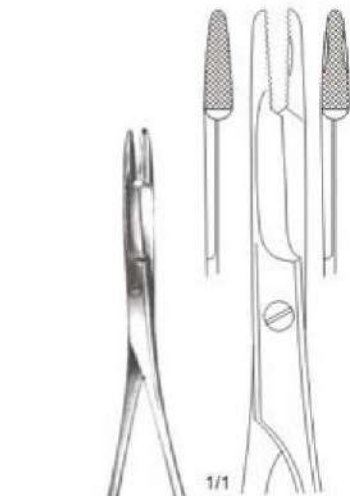

1/1

1/2

Olsen-Hegar
04-010-14
14 cm / 5 1/2"



1/1

1/2

Olsen-Hegar
04-011-14 14 cm / 5 1/2"
04-011-16 16.5 cm / 6 1/2"
04-011-18 18 cm / 7"

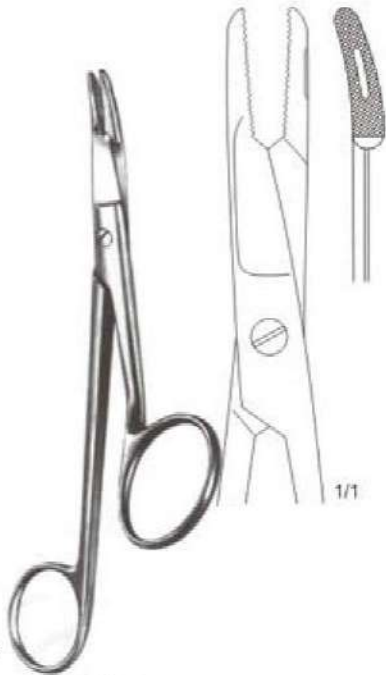

1/1

1/2

Gillies
04-012-16
16 cm / 6 1/4"



1/1

04-013-14
14 cm / 5 1/2"

04-014-17
17 cm / 6 3/4"

04-015-20
20 cm / 8"

Mathieu
04-013-14 - 04-015-20

NEEDLE HOLDERS

Tungsten Carbide Needle Holders



Webster TC
04-016-13
13 cm / 5"



Derf TC
04-017-12
12 cm / 4 1/2"



Hegar-Baumgartner TC
04-018-13 - 04-018-14

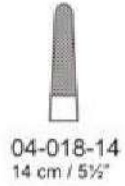
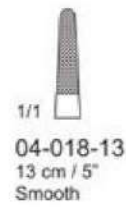

Halsey TC
04-019-13 - 04-020-13
13 cm / 5"



Webster TC
04-021-12
12 cm / 4 1/2"



Crile-Wood TC
04-022-15
15 cm / 6"



NEEDLE HOLDERS

Tungsten Carbide Needle Holders

Inches



1/1			1/1		
04-023-16	04-023-18	04-023-20	04-024-20	04-024-24	04-024-26
16 cm / 6 1/4"	18 cm / 7"	20 cm / 8"	20 cm / 8"	24 cm / 9 1/2"	26 cm / 10 1/4"
1/1					
04-023-24	04-023-26	04-023-30			
24 cm / 9 1/2"	26 cm / 10 1/4"	30 cm / 12"			

Mayo-Hegar TC
04-023-16 - 04-023-30

Mayo-Hegar (Heaney) TC
04-024-20 - 04-024-26

1/1				
04-025-18	04-025-20	04-025-23	04-026-18	04-026-20
18 cm / 7"	20 cm / 8"	23 cm / 9"	18 cm / 7"	20 cm / 8"
1/1				
04-025-26	04-025-31	04-025-37		
26 cm / 10 1/4"	31 cm / 12 1/4"	37 cm / 14 1/2"		

DeBakey TC
04-025-18 - 04-025-37

Microvascular TC
04-026-18 - 04-026-20

NEEDLE HOLDERS

Tungsten Carbide Needle Holders



Olsen-Heger TC
04-027-14 - 04-027-18



1/1
04-027-14
14 cm / 5½"



04-027-17
16.5 cm / 6½"



04-027-18
18 cm / 7"



Gillies TC
04-028-16
16 cm / 6¼"

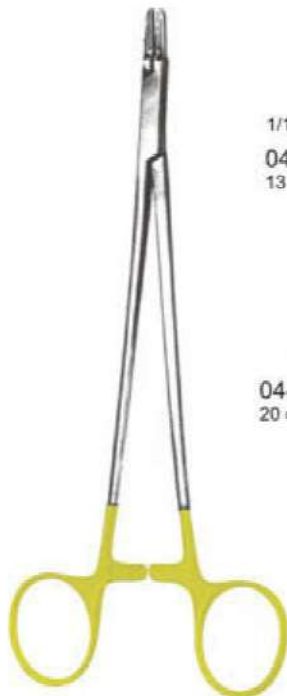

Ryder (Medro) TC
04-029-13 - 04-029-26



1/1
04-029-13
13 cm / 5"



04-029-15
15 cm / 6"



04-029-18
18 cm / 7"



04-029-20
20 cm / 8"



04-029-23
23 cm / 9"



04-029-26
26 cm / 10¼"



Ryder Vascular TC
04-030-13 - 04-030-26



1/1
04-030-13
13 cm / 5"



04-030-15
15 cm / 6"



04-030-18
18 cm / 7"



04-030-20
20 cm / 8"



04-030-23
23 cm / 9"



04-030-26
26 cm / 10¼"

NEEDLE HOLDERS

Tungsten Carbide Needle Holders



04-031-14
14 cm / 5½"

04-031-17
17 cm / 6½"

04-031-20
20 cm / 8"

Mathieu TC
04-031-14 - 04-031-20



04-032-15
15 cm / 6"

Wire Twister TC
04-032-15



04-032-20
20 cm / 8"

Wire Twister TC
04-032-20



Inches

NEEDLE HOLDERS

Tungsten Carbide Needle Holders



Langenbeck TC
 04-033-14 14 cm / 5½"
 04-033-16 16 cm / 7¼"
 04-033-18 18 cm / 7"
 04-033-20 20 cm / 9"
 04-033-23 23 cm / 9"



Wire Twister TC
 04-034-13 13 cm / 5½"
 04-034-16 16 cm / 7¼"
 04-034-18 18 cm / 7"



Wire Twister (Heavy) TC
 04-035-18



Wire Twister (Flat) TC
 04-036-16 - 04-037-20

DRESSING & TISSUE FORCEPS

Dressing & Tissue Forceps

Inches



Tissue 2x3
05-003-11 - 05-003-25

- | | | | | | | | |
|-----|----------------------------|-------------------------|----------------------------|--------------------------|-------------------------|-------------------------|--------------------------|
| 1/1 | | | | | | | |
| | 05-003-11
11,5 cm / 4½" | 05-003-13
13 cm / 5" | 05-003-14
14,5 cm / 5½" | 05-003-16
16 cm / 6½" | 05-003-18
18 cm / 7" | 05-003-20
20 cm / 8" | 05-003-25
25 cm / 10" |

- | | | | | | | | | | | |
|--------------------------|-----|--------------------------------------|--------------------------|-----|-------------------------|-----|---------------------------------------|-----|--------------------------------------|--------------------------|
| | 1/1 | | | 1/1 | | 1/1 | | 1/1 | | |
| 05-004-12
12 cm / 4½" | | 05-004-15
15 cm / 6"
1x2 Teeth | 05-005-12
12 cm / 4½" | | 05-005-15
15 cm / 6" | | 05-006-12
12 cm / 4½"
1x2 Teeth | | 05-006-15
15 cm / 6"
1x2 Teeth | 05-007-12
12 cm / 4½" |
- Mini Adson
05-004-12 - 05-004-12
- Adson
05-005-12 - 05-006-15
- Adson-Brown
05-007-12

OPHTHALMIC

04



Ophthalmic Instruments



FIVE S SURGICAL

OPHTHALMIC SURGERY INSTRUMENTS

Eye Speculum Forceps



Weiss
 06-001-01 Solid for adults
 06-001-02 Solid for infants
 06-001-03 Fenestrated for adults
 06-001-04 Fenestrated for infants



Castroviejo
 06-002-01 Small
 06-002-02 Medium
 06-002-03 Large



Holtzheimer 4-teeth
 06-003-10 10 cm 4* Sharp Str.
 06-004-10 10 cm 4* Blunt Str.
 06-005-10 10 cm 4* Sharp Cvd
 06-006-10 10 cm 4* Blunt Cvd

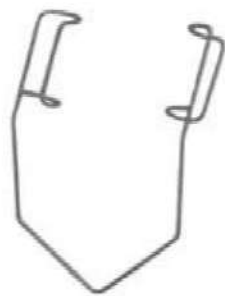

Barraquer
 06-007-01 Fenestrated
 06-007-02 Fenestrated for infants



Desmarres
 9 cm / 3 1/2



20mm
1/1
06-008-09



25mm
06-009-09



30mm
06-010-09



Lambert
 9.5 cm / 3 3/4
 06-011-09

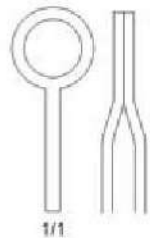

1/1



1/2

Bishop-Harmon
06-012-09 - 06-015-09
8.5cm / 3 1/2"



1/1

06-012-09 Fine Tip
06-013-09 Standard



1/1

1x2 teeth
06-014-09 Fine Tip
06-015-09 Standard



Gill
06-016-07 - 06-018-07
7.0cm / 3 1/4"



1/1

1x2 teeth
06-016-07 Extra Delicate
06-017-07 Standard



1/1

Gill-Chandler
06-018-07



1/2

Gill-Hess
06-019-07
7.5 cm / 3"



1/1

1x2 teeth



Colibri
With tying platform
8.3 cm / 3 1/4"



06-020-08



06-021-08
Extra delicate



Bonn
Suture Forceps
8.3 cm / 3 1/4"



06-022-08



OPHTHALMIC SURGERY INSTRUMENTS

Eye Speculum Forceps

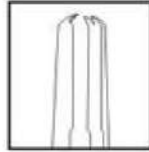
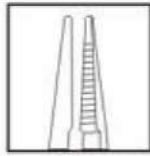

1/1
06-026-11



06-027-11

Castroviejo
06-023-11
11 cm / 4 1/2"

Castroviejo
06-024-12 0.12 mm
06-024-30 0.30 mm
06-024-50 0.50 mm
06-024-70 0.70 mm
11 cm / 4 1/2"

Castroviejo TC
06-025-30 0.30 mm
06-025-50 0.50 mm
10.5 cm / 4 1/2"

Berke
10.8 cm / 4 1/4"

Tip 0.3 mm



1/1

06-028-12 12 cm / 4 3/4"
06-028-15 15 cm / 6"

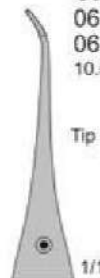

1/1

06-029-12 12 cm / 4 3/4"
06-029-15 15 cm / 6"



1/2

Micro Suture Tying



Tip 0.6 cm

1/1

06-028-18 18 cm / 7"
06-028-23 23 cm / 9"



1/1

06-029-18 18 cm / 7"
06-029-23 23 cm / 9"



1/2

Rhoton
18 cm / 7"



1/1

06-030-18 Str
06-031-18 Cvd



1/1



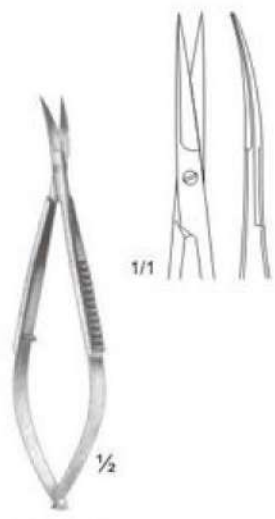

06-032-11
11 cm / 4 1/2"



06-033-12
12 cm / 4 3/4"

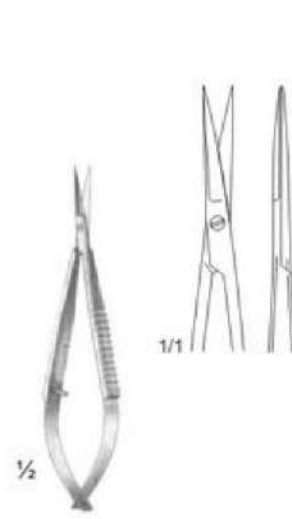

06-034-09
09 cm / 3 1/2"

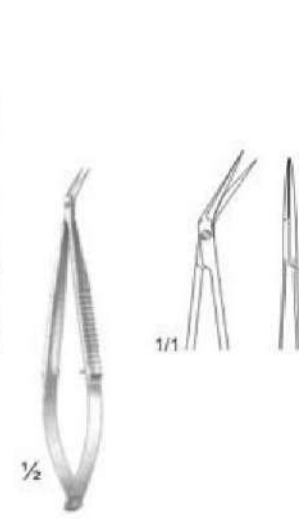

06-035-09
09 cm / 3 1/2"



Westcott
06-036-11 - 06-037-11
11 cm / 4 1/2"

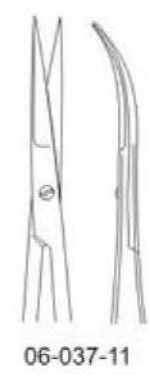

06-036-11

06-037-11



06-038-18
06-040-18
18.5 cm / 7 1/4"



06-038-18



06-039-18



06-040-18

OPHTHALMIC SURGERY INSTRUMENTS

Micro Scissors



Vannas-Tubingen
06-041-08 Str
06-042-08 Cvd
08 cm / 3"



06-043-08 Str



06-044-08 Cvd



06-045-08 Bent



06-046-08 Angled on flat



06-047-08 str



06-048-08 Cvd

Vannas very delicate
08 cm / 3"

Trabecular
08 cm / 3"

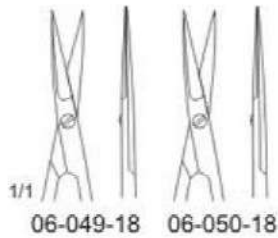

1/1
06-049-18 06-050-18



1/1
06-051-18

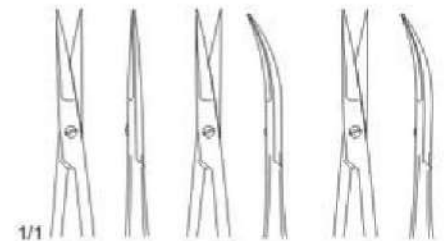

1/1
06-052-14 14 cm / 5 1/2"
06-053-15 15 cm / 6"
06-054-15 15 cm / 6"
1 blade serr.
Reill



1/2

06-049-18 - 06-050-18
18 cm / 7 1/4"



1/2

Hepp/Scheidel
18 cm / 7 1/4"



1/2

06-052-14 - 06-054-15



Ribbon Scissors

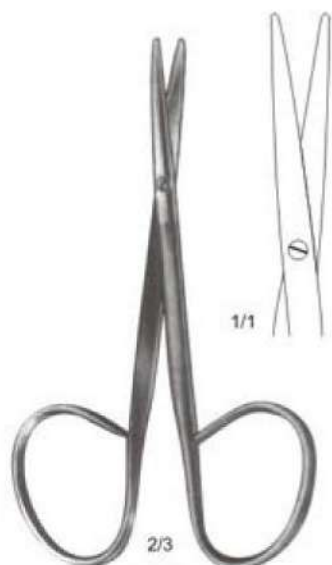

06-055-10
10 cm / 4"



06-056-10
10 cm / 4"

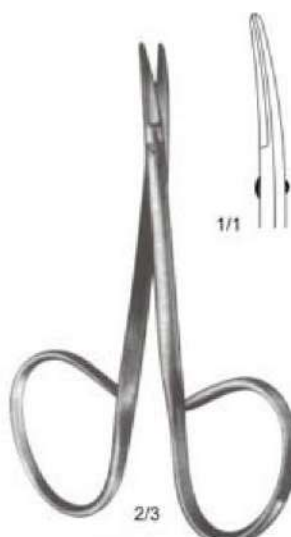

06-057-05
9.5 cm / 3 7/8"

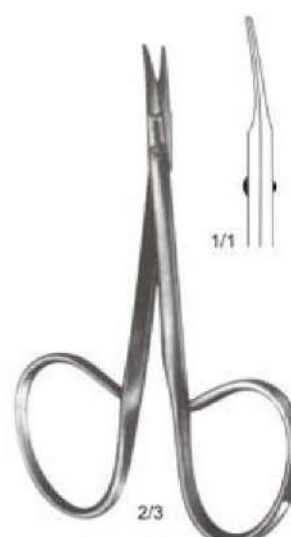

06-058-09
9.5 cm / 3 7/8"



Stevens
06-059-10
10 cm / 4"



Stevens
06-060-10
10 cm / 4"



Stevens
06-061-10
10 cm / 4"



Stevens
06-062-10
10 cm / 4"



OPHTHALMIC SURGERY INSTRUMENTS

Micro Scissors

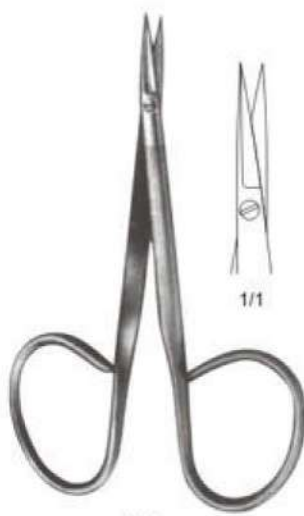

2/3
06-063-09
9.5 cm / 3 3/4"

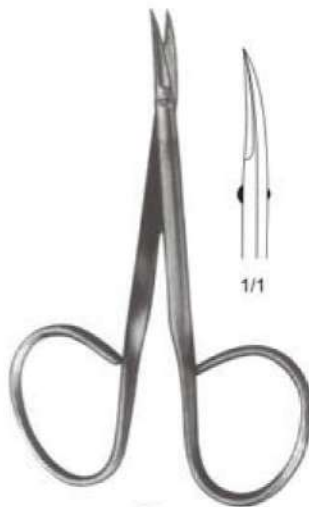

2/3
06-064-09
9.5 cm / 3 3/4"

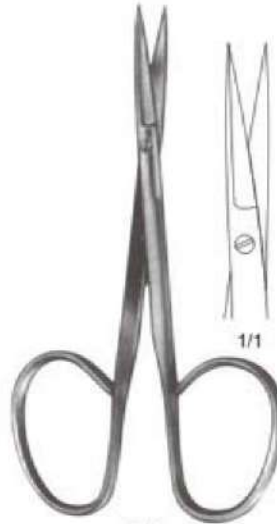

2/3
06-065-09
9.5 cm / 3 3/4"

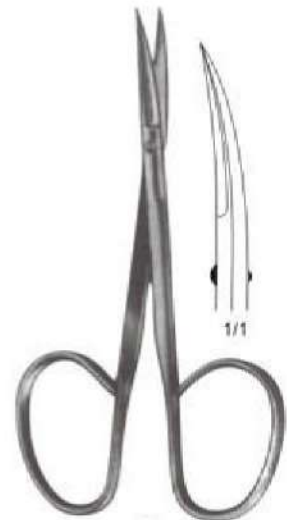

2/3
06-066-09
9.5 cm / 3 3/4"



2/3
Knapp
06-067-12
12 cm / 4 3/4"



2/3
Knapp
06-068-12
12 cm / 4 3/4"



2/3
Knapp
06-069-12
12 cm / 4 3/4"



2/3
Knapp
06-070-12
12 cm / 4 3/4"



OPHTHALMIC SURGERY INSTRUMENTS

Micro Scissors Tungsten Carbide

Inches

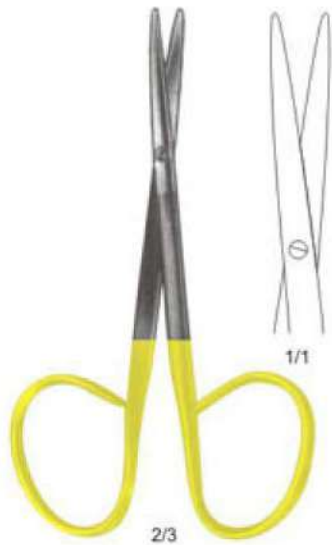

06-071-10 TC
10 cm / 4"



06-072-10 TC
10 cm / 4"



06-073-09 TC
9.5 cm / 3 3/4"



06-074-09 TC
9.5 cm / 3 3/4"

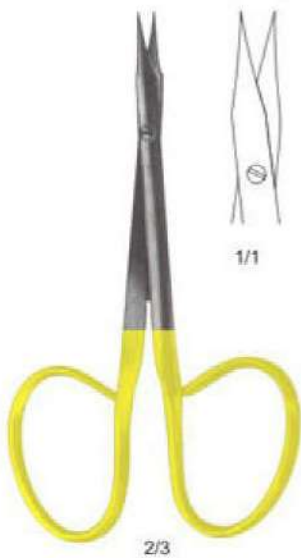

Stevens TC
06-075-10
10 cm / 4"



Stevens TC
06-076-10
10 cm / 4"



Stevens TC
06-077-10
10 cm / 4"



Stevens TC
06-078-10
10 cm / 4"



OPHTHALMIC SURGERY INSTRUMENTS

Micro Scissors Tungsten Carbide

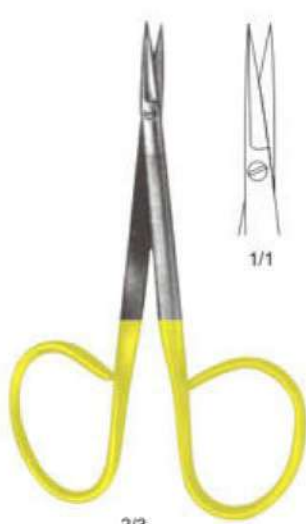

2/3
06-079-09 TC
9.5 cm / 3 3/4"



2/3
06-080-09 TC
9.5 cm / 3 3/4"

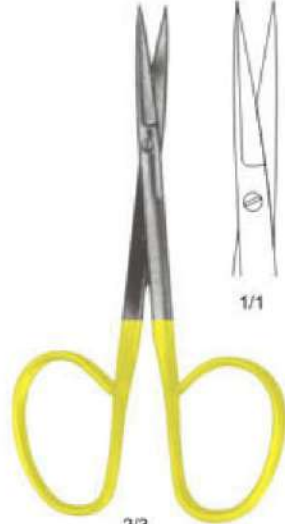

2/3
06-081-09 TC
9.5 cm / 3 3/4"



2/3
06-082-09 TC
9.5 cm / 3 3/4"



2/3
Knapp TC
06-083-12
12 cm / 4 3/4"



2/3
Knapp TC
06-084-12
12 cm / 4 3/4"



2/3
Knapp TC
06-085-12
12 cm / 4 3/4"



2/3
Knapp TC
06-086-12
12 cm / 4 3/4"



2/3
06-087-10 SC
10 cm / 4"



2/3
06-088-10 SC
10 cm / 4"



2/3
06-089-09 SC
9.5 cm / 3 3/4"



2/3
06-090-09 SC
9.5 cm / 3 3/4"



2/3
Stevens
06-091-10 SC
10 cm / 4"



2/3
Stevens
06-092-10 SC
10 cm / 4"

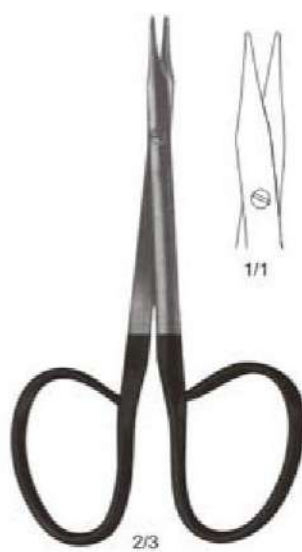

2/3
Stevens
06-093-10 SC
10 cm / 4"



2/3
Stevens
06-094-10 SC
10 cm / 4"

OPHTHALMIC SURGERY INSTRUMENTS

Micro Scissors Tungsten Carbide



2/3
06-095-09 SC
9.5 cm / 3 3/4"



2/3
06-096-09 SC
9.5 cm / 3 3/4"

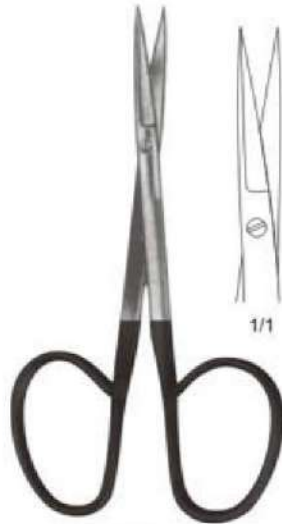

2/3
06-097-09 SC
9.5 cm / 3 3/4"



2/3
06-098-09 SC
9.5 cm / 3 3/4"



2/3
Knapp SC
06-099-12
12 cm / 4 3/4"



2/3
Knapp SC
06-100-12
12 cm / 4 3/4"



2/3
Knapp SC
06-101-12
12 cm / 4 3/4"



2/3
Knapp SC
06-102-12
12 cm / 4 3/4"



Micro-Castroviejo
With out lock
9.5 cm / 3 1/2"



Micro-Castroviejo
With lock
9.5 cm / 3 1/2"

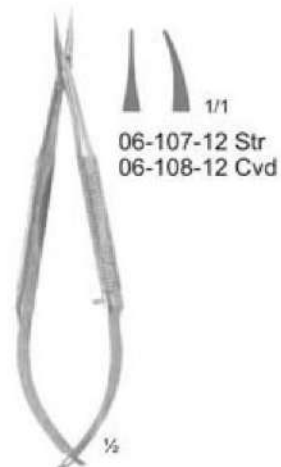

Barraquer
Without lock
12 cm / 4 3/4"



Micro-Castroviejo TC
With out lock
14 cm / 5 1/2"



Micro-Castroviejo TC
With lock
14 cm / 5 1/2"



Barraquer
With lock
12 cm / 4 3/4"

OPHTHALMIC SURGERY INSTRUMENTS

Micro Needle Holders



Castroviejo
Without lock
18 cm / 7"

Delicate

1/1



- 06-115-14 14 cm / 5½" Str/Smooth
- 06-115-18 18 cm / 7" Str/Smooth
- 06-115-21 21 cm / 8¼" Str/Smooth
- 06-115-23 23 cm / 8¾" Str/Smooth
- 06-116-14 14 cm / 5½" Str/Serrated
- 06-116-18 18 cm / 7" Str/Serrated
- 06-116-21 21 cm / 8¼" Str/Serrated
- 06-116-23 23 cm / 8¾" Str/Serrated

Micro

1/1



- 06-117-14 14 cm / 5½" Cvd/Smooth
- 06-117-18 18 cm / 7" Cvd/Smooth
- 06-117-21 21 cm / 8¼" Cvd/Smooth
- 06-117-23 23 cm / 8¾" Cvd/Smooth
- 06-118-14 14 cm / 5½" Cvd/Serrated
- 06-118-18 18 cm / 7" Cvd/Serrated
- 06-118-21 21 cm / 8¼" Cvd/Serrated
- 06-118-23 23 cm / 8¾" Cvd/Serrated



Castroviejo
With lock
18 cm / 7"

Delicate

1/1



- 06-119-14 14 cm / 5½" Str/Smooth
- 06-119-18 18 cm / 7" Str/Smooth
- 06-119-21 21 cm / 8¼" Str/Smooth
- 06-119-23 23 cm / 8¾" Str/Smooth
- 06-120-14 14 cm / 5½" Str/Serrated
- 06-120-18 18 cm / 7" Str/Serrated
- 06-120-21 21 cm / 8¼" Str/Serrated
- 06-120-23 23 cm / 8¾" Str/Serrated

Micro

1/1



- 06-121-14 14 cm / 5½" Cvd/Smooth
- 06-121-18 18 cm / 7" Cvd/Smooth
- 06-121-21 21 cm / 8¼" Cvd/Smooth
- 06-121-23 23 cm / 8¾" Cvd/Smooth
- 06-122-14 14 cm / 5½" Cvd/Serrated
- 06-122-18 18 cm / 7" Cvd/Serrated
- 06-122-21 21 cm / 8¼" Cvd/Serrated
- 06-122-23 23 cm / 8¾" Cvd/Serrated





Barraquer
Without lock
23 cm / 9"



1/1
Delicate



1/1
Micro

- 06-123-14 14 cm / 5½" Str
- 06-123-16 16 cm / 6" Str
- 06-123-18 18 cm / 7" Str
- 06-123-21 21 cm / 8¼" Str
- 06-123-23 23 cm / 8¾" Str
- 06-124-14 14 cm / 5½" Cvd
- 06-124-16 16 cm / 6" Cvd
- 06-124-18 18 cm / 7" Cvd
- 06-124-21 21 cm / 8¼" Cvd
- 06-124-23 23 cm / 8¾" Cvd

- 06-123-14 14 cm / 5½" Str
- 06-123-16 16 cm / 6" Str
- 06-123-18 18 cm / 7" Str
- 06-123-21 21 cm / 8¼" Str
- 06-123-23 23 cm / 8¾" Str
- 06-124-14 14 cm / 5½" Cvd
- 06-124-16 16 cm / 6" Cvd
- 06-124-18 18 cm / 7" Cvd
- 06-124-21 21 cm / 8¼" Cvd
- 06-124-23 23 cm / 8¾" Cvd



Barraquer
With lock
23 cm / 9"



1/1
Delicate



1/1
Micro

- 06-127-14 14 cm / 5½" Str
- 06-127-15 15 cm / 6" Str
- 06-127-18 18 cm / 7" Str
- 06-127-21 21 cm / 8¼" Str
- 06-127-23 23 cm / 8¾" Str
- 06-128-14 14 cm / 5½" Cvd
- 06-128-15 15 cm / 6" Cvd
- 06-128-18 18 cm / 7" Cvd
- 06-128-21 21 cm / 8¼" Cvd
- 06-128-23 23 cm / 8¾" Cvd

- 06-129-14 14 cm / 5½" Str
- 06-129-15 15 cm / 6" Str
- 06-129-18 18 cm / 7" Str
- 06-129-21 21 cm / 8¼" Str
- 06-129-23 23 cm / 8¾" Str
- 06-130-14 14 cm / 5½" Cvd
- 06-130-15 15 cm / 6" Cvd
- 06-130-18 18 cm / 7" Cvd
- 06-130-21 21 cm / 8¼" Cvd
- 06-130-23 23 cm / 8¾" Cvd



OPHTHALMIC SURGERY INSTRUMENTS

Tungsten Carbide Micro Needle Holders



Castroviejo TC
Without lock
18 cm / 7"

- 06-131-14 14 cm / 5½" Str
- 06-131-18 18 cm / 7" Str
- 06-131-21 21 cm / 8¼" Str
- 06-131-23 23 cm / 8¾" Str
- 06-132-14 14 cm / 5½" Cvd
- 06-132-18 18 cm / 7" Cvd
- 06-132-21 21 cm / 8¼" Cvd
- 06-132-23 23 cm / 8¾" Cvd



Castroviejo TC
With lock
18.0 cm / 7"

- 06-133-14 14 cm / 5½" Str
- 06-133-18 18 cm / 7" Str
- 06-133-21 21 cm / 8¼" Str
- 06-133-23 23 cm / 8¾" Str
- 06-134-14 14 cm / 5½" Cvd
- 06-134-18 18 cm / 7" Cvd
- 06-134-21 21 cm / 8¼" Cvd
- 06-134-23 23 cm / 8¾" Cvd



OPHTHALMIC SURGERY INSTRUMENTS

Tungsten Carbide Micro Needle Holders



Barraquer TC
With lock
23 cm / 9"



1/1
Delicate

06-135-14	14 cm / 5½"	Str
06-135-15	15 cm / 6"	Str
06-135-18	18 cm / 7"	Str
06-135-21	21 cm / 8¼"	Str
06-135-23	23 cm / 8¾"	Str
06-136-14	14 cm / 5½"	Cvd
06-136-15	15 cm / 6"	Cvd
06-136-18	18 cm / 7"	Cvd
06-136-21	21 cm / 8¼"	Cvd
06-136-23	23 cm / 8¾"	Cvd



1/1
Micro

06-137-14	14 cm / 5½"	Str
06-137-15	15 cm / 6"	Str
06-137-18	18 cm / 7"	Str
06-137-21	21 cm / 8¼"	Str
06-137-23	23 cm / 8¾"	Str
06-138-14	14 cm / 5½"	Cvd
06-138-15	15 cm / 6"	Cvd
06-138-18	18 cm / 7"	Cvd
06-138-21	21 cm / 8¼"	Cvd
06-138-23	23 cm / 8¾"	Cvd



Barraquer TC
With lock
23 cm / 9"



1/1
Delicate

06-139-14	14 cm / 5½"	Str
06-139-15	15 cm / 6"	Str
06-139-18	18 cm / 7"	Str
06-139-21	21 cm / 8¼"	Str
06-139-23	23 cm / 8¾"	Str
06-140-14	14 cm / 5½"	Cvd
06-140-15	15 cm / 6"	Cvd
06-140-18	18 cm / 7"	Cvd
06-140-21	21 cm / 8¼"	Cvd
06-140-23	23 cm / 8¾"	Cvd



1/1
Micro

06-141-14	14 cm / 5½"	Str
06-141-15	15 cm / 6"	Str
06-141-18	18 cm / 7"	Str
06-141-21	21 cm / 8¼"	Str
06-141-23	23 cm / 8¾"	Str
06-142-14	14 cm / 5½"	Cvd
06-142-15	15 cm / 6"	Cvd
06-142-18	18 cm / 7"	Cvd
06-142-21	21 cm / 8¼"	Cvd
06-142-23	23 cm / 8¾"	Cvd

OPHTHALMIC SURGERY INSTRUMENTS

Eye Caliper & Retractors



Castroviejo
 06-143-01 15 mm Str
 06-143-02 15 mm Str with teflon
 06-143-03 15 mm Cvd
 06-143-04 15 mm Cvd with teflon



Castroviejo
 06-144-01 20 cm Str
 06-144-02 20 cm Str with teflon
 06-144-03 20 cm Cvd
 06-144-04 20 cm Cvd with teflon

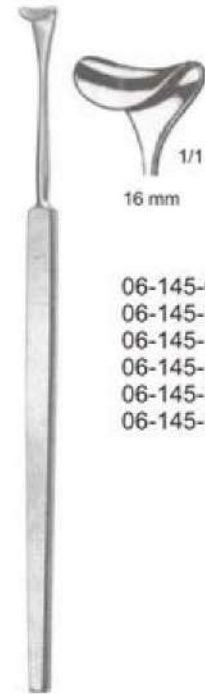

06-145-08 8 mm
 06-145-10 10 mm
 06-145-12 12 mm
 06-145-14 14 mm
 06-145-16 16 mm
 06-145-18 18 mm

Desmarres
Eye Retractor



ALM
 4x4 prongs
 7 cm / 2 3/4"



06-146-07 Sharp

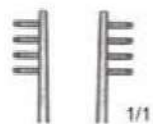

06-147-07 Blunt



ALM
 4x4 prongs
 10 cm / 4"



06-148-10 Sharp

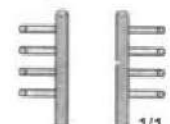

06-149-10 Blunt

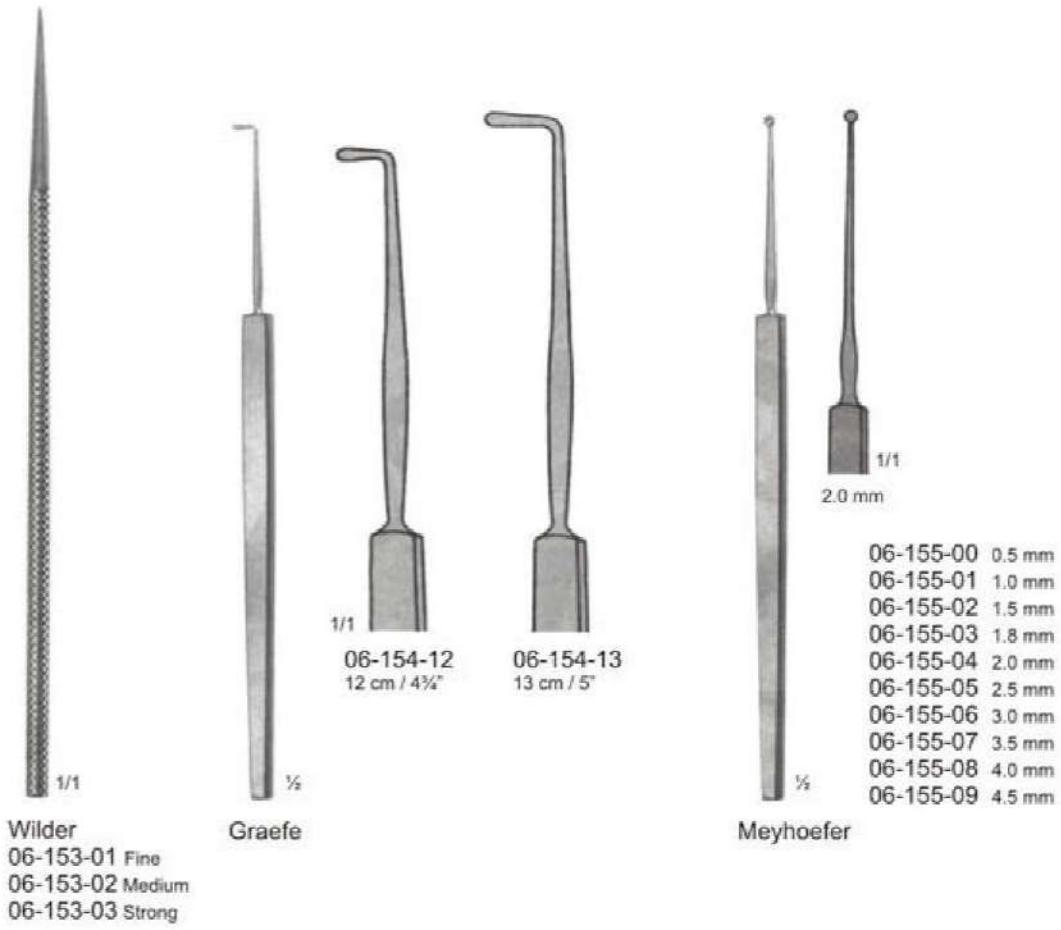
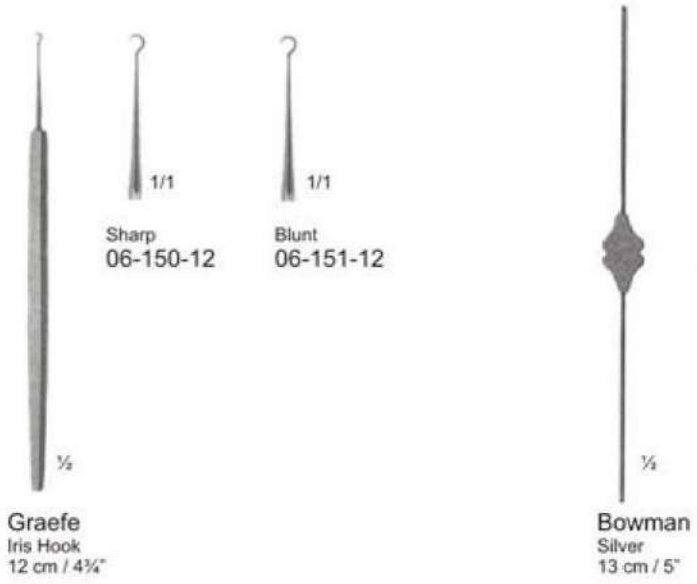

NEURO SURGERY

05

Neuro Surgery Instruments



FIVE S SURGICAL

NEURO SURGERY INSTRUMENTS

Laminectomy Ronger

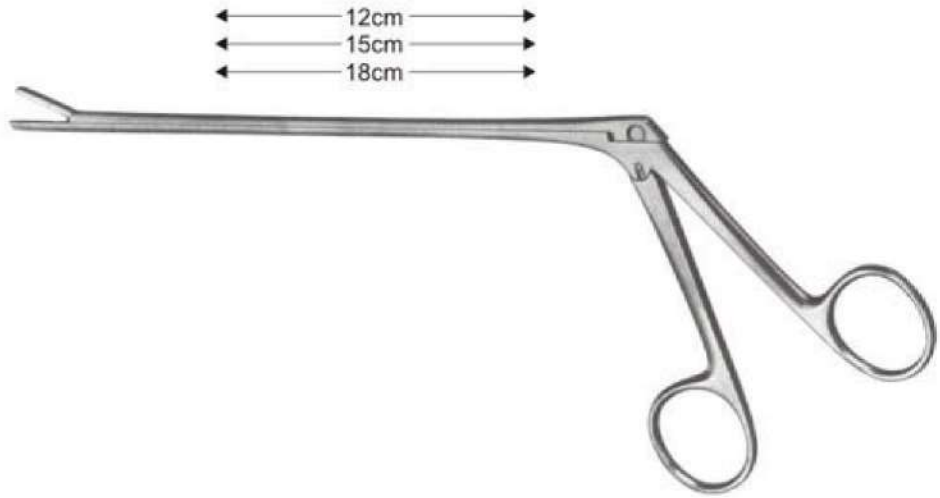

Cushing
2 mm
1/1

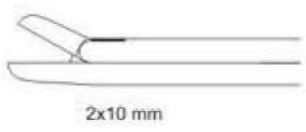

2x10 mm
08-001-12 12 cm
08-001-15 15 cm
08-001-18 18 cm
Str.

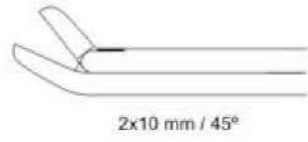

2x10 mm / 45°
08-002-12 12 cm
08-002-15 15 cm
08-002-18 18 cm
Upward

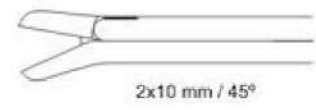

2x10 mm / 45°
08-003-12 12 cm
08-003-15 15 cm
08-003-18 18 cm
Downward

Love Gruenwald
3 mm
1/1

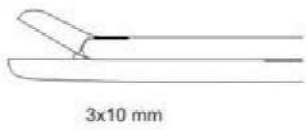

3x10 mm
08-004-12 12 cm
08-004-15 15 cm
08-004-18 18 cm

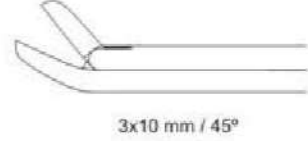

3x10 mm / 45°
08-005-12 12 cm
08-005-15 15 cm
08-005-18 18 cm



3x10 mm / 45°
08-006-12 12 cm
08-006-15 15 cm
08-006-18 18 cm

Spurling
4 mm
1/1

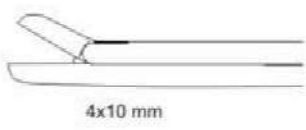

4x10 mm
08-007-12 12 cm
08-007-15 15 cm
08-007-18 18 cm

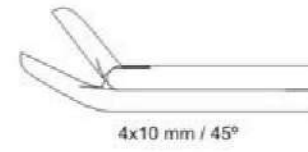

4x10 mm / 45°
08-008-12 12 cm
08-008-15 15 cm
08-008-18 18 cm

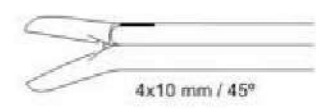

4x10 mm / 45°
08-009-12 12 cm
08-009-15 15 cm
08-009-18 18 cm

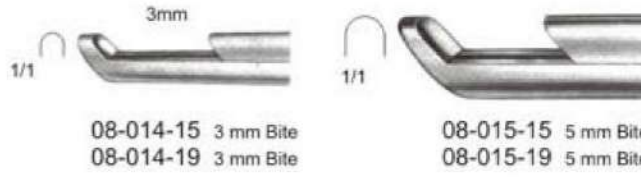

Colclough 15 cm / 6" Shaft
08-014-15 3 mm Bite
08-015-15 5 mm Bite

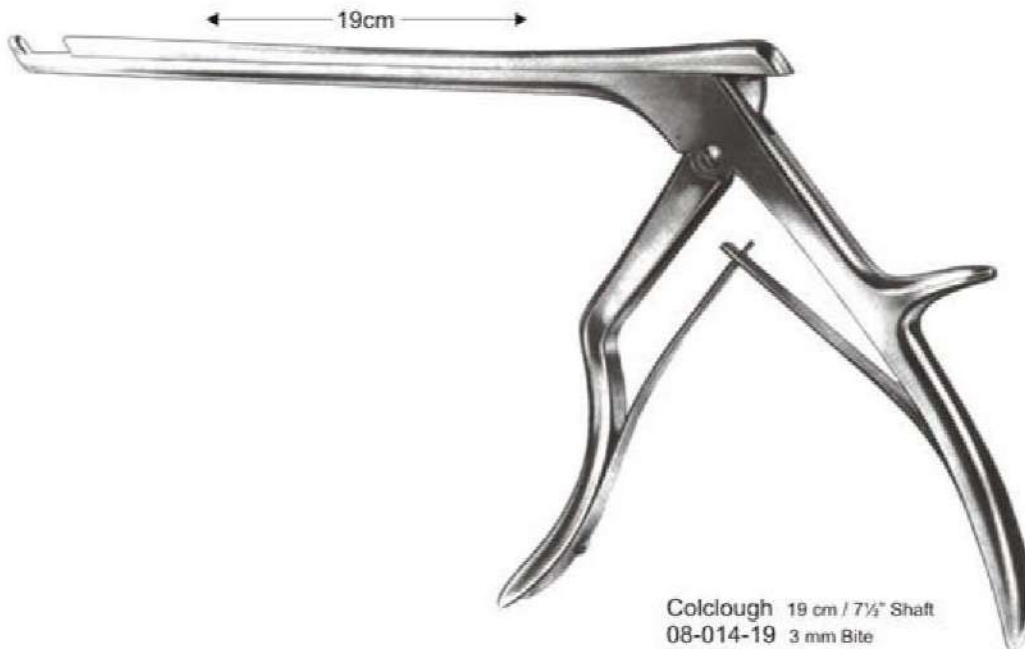

Colclough 19 cm / 7 1/2" Shaft
08-014-19 3 mm Bite
08-015-19 5 mm Bite



NEURO SURGERY INSTRUMENTS

Laminectomy Rongeur

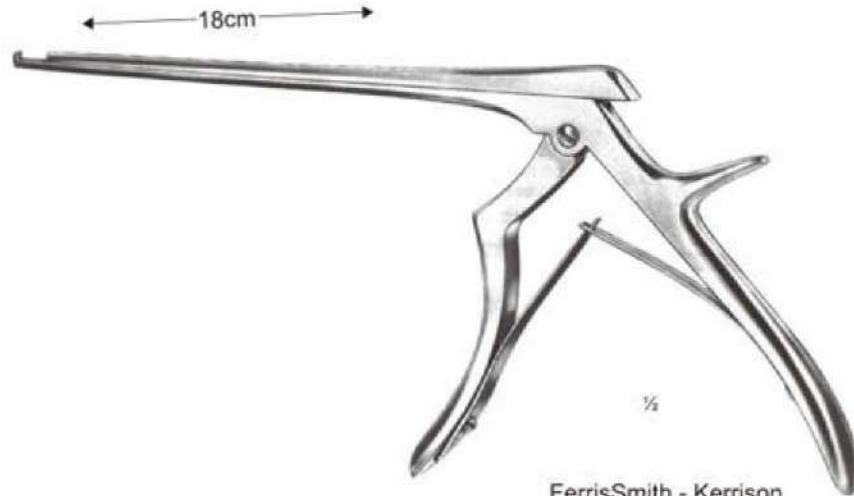

FerrisSmith - Kerrison
08-016-01 - 08-018-06

- Upward Cutting**
- 1/1 □ 1mm 08-016-01
 - 2mm 08-016-02
 - 3mm 08-016-03
 - 4mm 08-016-04
 - 5mm 08-016-05
 - 6mm 08-016-06

- Downward Cutting**
- 1/1 □ 1mm 08-017-01
 - 2mm 08-017-02
 - 3mm 08-017-03
 - 4mm 08-017-04
 - 5mm 08-017-05
 - 6mm 08-017-06

- Forward Cutting**
- 1/1 □ 1mm 08-018-01
 - 2mm 08-018-02
 - 3mm 08-018-03
 - 4mm 08-018-04
 - 5mm 08-018-05
 - 6mm 08-018-06



ENT INSTRUMENTS

06



FIVE S SURGICAL

ENT Instruments

ENT INSTRUMENTS

Mirrors, Tonsil Punch, Currettes & Dilator Forceps



- Laryngeal Mirror**
- | | | | |
|-----------|------|-----------|------|
| 10-001-08 | 8mm | 10-001-24 | 24mm |
| 10-001-10 | 10mm | 10-001-26 | 26mm |
| 10-001-12 | 12mm | 10-001-28 | 28mm |
| 10-001-14 | 14mm | 10-001-30 | 30mm |
| 10-001-16 | 16mm | | |
| 10-001-18 | 18mm | | |
| 10-001-20 | 20mm | | |
| 10-001-22 | 22mm | | |

- Laryngeal Mirror**
- | | |
|-----------|------|
| 10-002-08 | 8mm |
| 10-002-10 | 10mm |
| 10-002-12 | 12mm |
| 10-002-14 | 14mm |
| 10-002-16 | 16mm |
| 10-002-18 | 18mm |
| 10-002-20 | 20mm |
| 10-002-22 | 22mm |
| 10-002-24 | 24mm |
| 10-002-26 | 26mm |
| 10-002-28 | 28mm |
| 10-002-30 | 30mm |

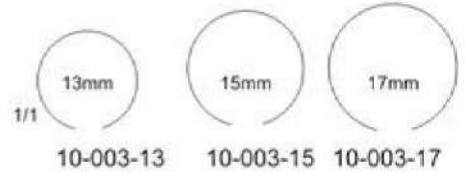

Hartmann
10-003-13 - 10-003-17



10-004-01 10-004-02 10-004-03



10-004-04 10-004-05 10-004-06

Coakley
10-004-01 - 10-004-06
17 cm / 6 1/2"

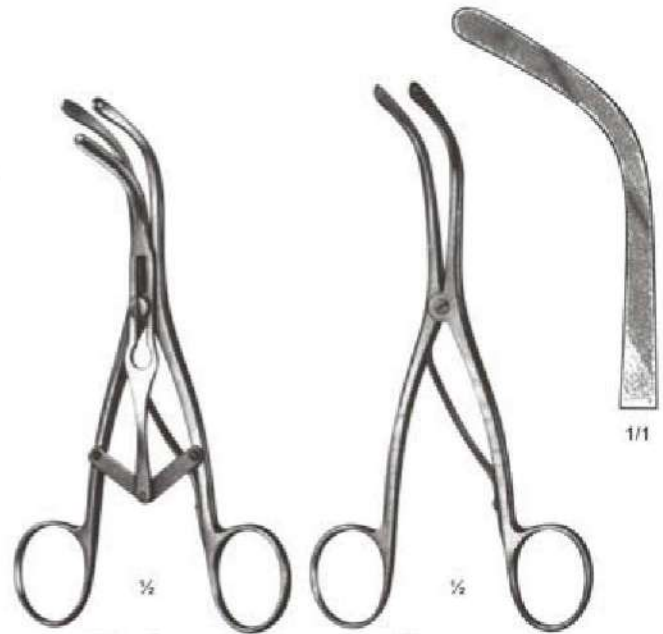

Labarde
10-005-14
14 cm / 5 1/2"

Trousseau
10-006-14
14 cm / 5 1/2"



ENT INSTRUMENTS

Mouth Gags



McIvor (Frame Only)
10-013-10



10-013-01
27x95 mm



10-013-02
22x85 mm



10-013-03
22x70 mm



Davis-Boyle (Frame Only)
10-014-00



10-014-01
27x105 mm



10-014-02
25x90 mm



10-014-03
25x75 mm



10-014-04
22x60 mm



10-014-05
20x25 mm



Jannings
10-015-09 9 cm /3½"
10-015-11 11 cm /4½"
10-015-13 13 cm /5"
10-015-15 15 cm /6"



Molt
10-016-11
11 cm / 4 1/2"



Molt
10-017-14
15 cm / 4 1/2"



Denhart
10-018-12
12 cm / 4 1/2"



Obwegeser
10-019-06 - 10-019-11
17.5 cm / 7 1/4"

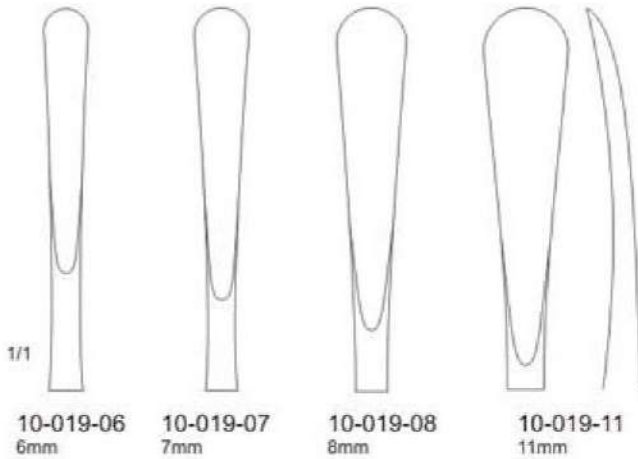

1/1

10-019-06
6mm

10-019-07
7mm

10-019-08
8mm

10-019-11
11mm

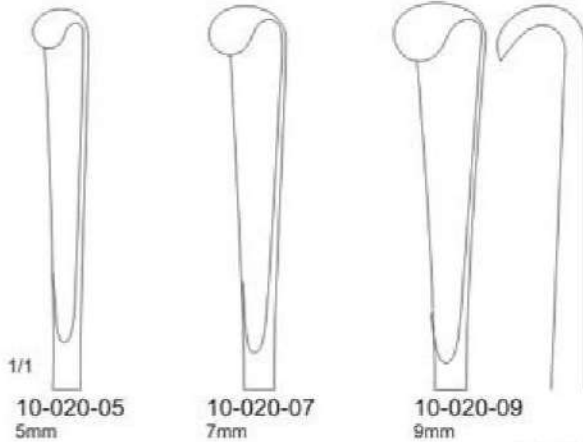

1/1

10-020-05
5mm

10-020-07
7mm

10-020-09
9mm



Obwegeser
10-020-05 - 10-020-09
20 cm / 8"



ENT INSTRUMENTS

Tounge Depressors



16mm



19mm



23mm

Tongue Depressor
10-021-14
14 cm / 5½"

Tongue Depressor
10-022-14
14 cm / 5½"



Haberer
10-023-30
30 cm / 12"



Haberer
10-024-20
20 cm / 7"



Wieder
10-022-00 (Set of 2)
10-022-28 28mm Blade Serrated
10-022-36 36mm Blade Serrated
14 cm / 5½"



Tuffier

- 10-023-13 13x203 mm
- 10-023-16 16x203 mm
- 10-023-19 19x203 mm
- 10-023-25 25x330 mm
- 10-023-38 38x330 mm
- 10-023-61 51x330 mm



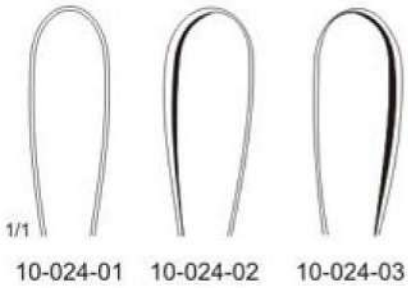

10-024-01 10-024-02 10-024-03

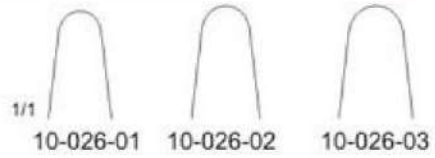

10-026-01 10-026-02 10-026-03



Voltolini
10-026-01 - 10-026-03

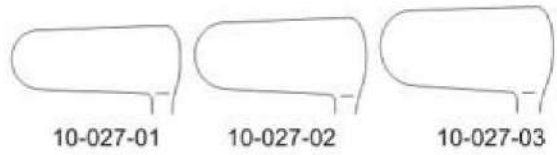

10-027-01 10-027-02 10-027-03



Goldsmith (Thudichum)
10-027-01 - 10-027-03



Cottle-Walsham
10-024-01 - 10-024-03
23 cm / 9"

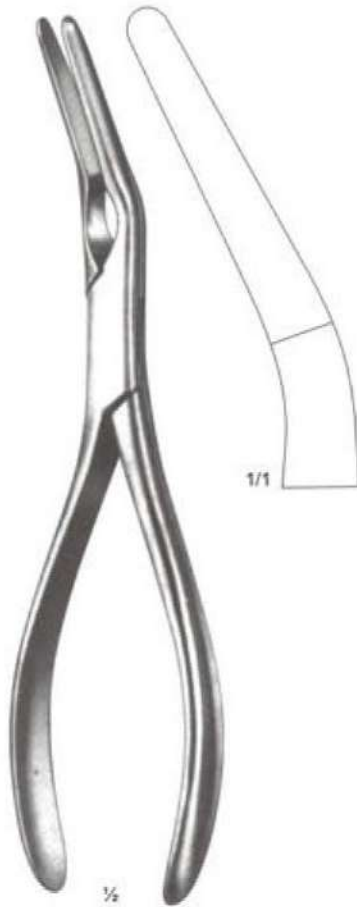

Asch
10-025-01
23 cm / 9"

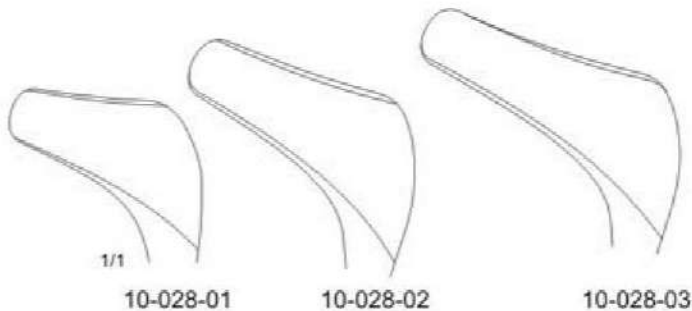

10-028-01 10-028-02 10-028-03



Hartmann-Halle
10-028-01 - 10-028-03
15 cm / 6"



ENT INSTRUMENTS

Nasal Speculams



Mod-Medro
10-029-13
13 cm / 5"



Mod-Medro
10-030-13
13 cm / 5"



Tieck-Halle
10-031-13
13.5 cm / 5 1/4"

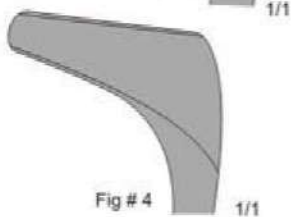
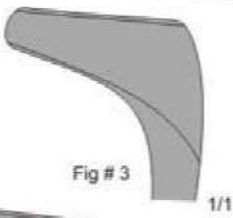
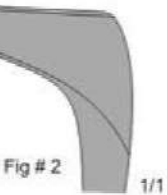
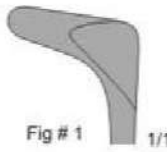

Hartmann
10-032-01 Fig # 1
10-032-02 Fig # 2
10-032-03 Fig # 3
10-032-04 Fig # 4



Mod-Wien
10-033-14
14.5 cm / 5 3/4"



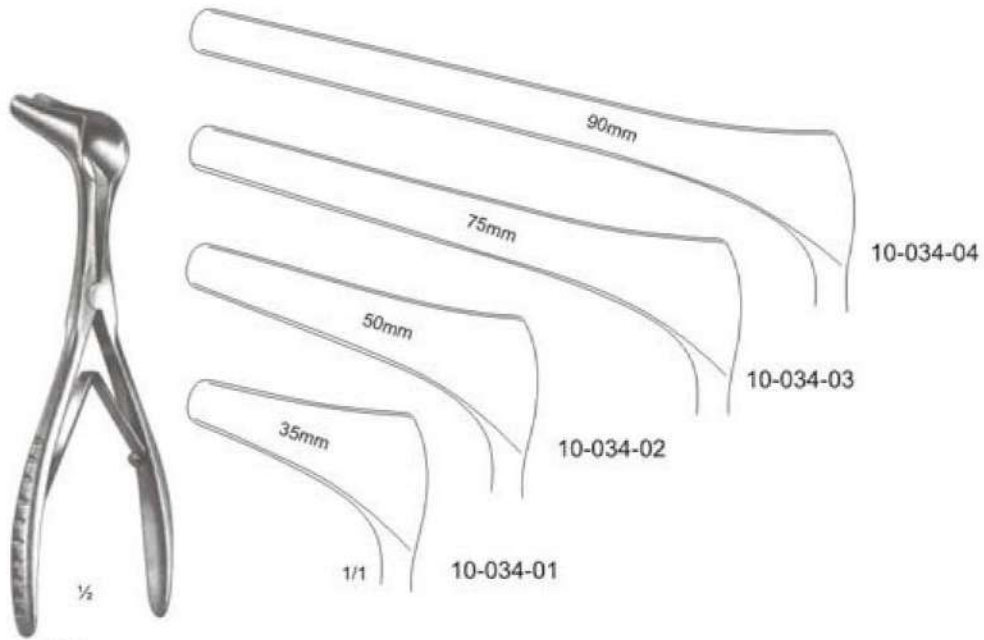

Killian
10-034-01 - 10-034-04
13 cm / 5"

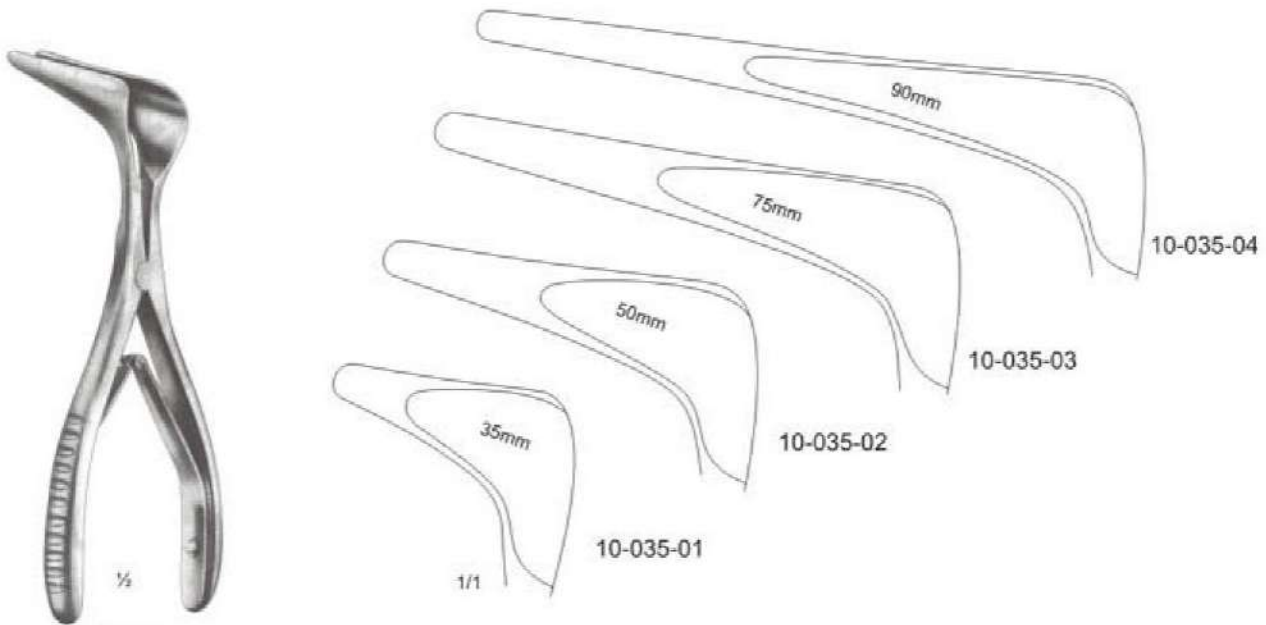

Cottle
10-035-01 - 10-035-04
15 cm / 6"



ENT INSTRUMENTS

Elevators & Nasal Knives



Joseph
10-036-16
16 cm / 6 1/4"



Joseph
10-037-16
16 cm / 6 1/4"



Freer
10-038-19
19 cm / 7 1/2"



Freer
10-039-18
18 cm / 7"



Freer
10-040-20
20.5 cm / 8"



Ballenger
10-041-03 - 10-041-05
20 cm / 8"



10-041-03
3mm



10-041-04
4mm



10-041-05
5mm



10-042-03
3mm

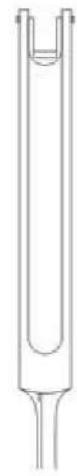

10-042-04
4mm



10-042-05
5mm

Ballenger
10-042-03 - 10-042-05
20 cm / 8"



Cottle
10-043-18
18 cm / 7"

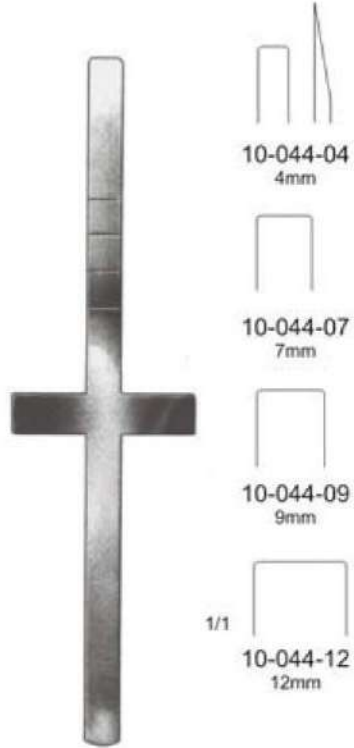

Cottle
10-044-04 - 10-044-12
18 cm / 7"



Cottle
10-045-18
18 cm / 7"



Cottle
10-046-18
18 cm / 7"



Cottle
10-047-18
18 cm / 7"



Cottle
10-047-18 - 10-048-12
18 cm / 7"



ENT INSTRUMENTS

Ear Speculas, Curettes & Loops







Toynbee
10-049-01 - 10-049-05

-  10-049-01
4mm
-  10-049-02
5.5mm
-  10-049-03
7mm
-  10-049-04
8.5mm
-  10-049-05
10mm



Lempert
10-050-01 - 10-050-05
17.5 cm / 7"

-  10-050-01
-  10-050-02
-  10-050-03
-  10-050-04
-  10-050-05



Lempert
10-051-20
20.5 cm / 8 1/4"



Lempert
10-052-18
18 cm / 7 1/4"



Billeau
10-053-01 - 10-053-03
16.5 cm / 6 1/2"

-  10-053-01
-  10-053-02
-  10-053-03





Buck
10-054-01 - 10-054-14
16.5 cm / 6 1/2"

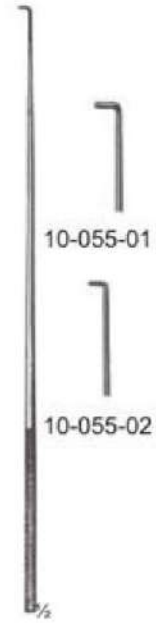
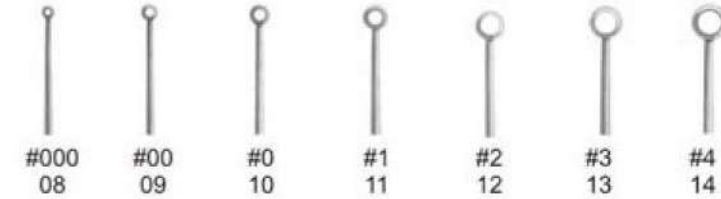
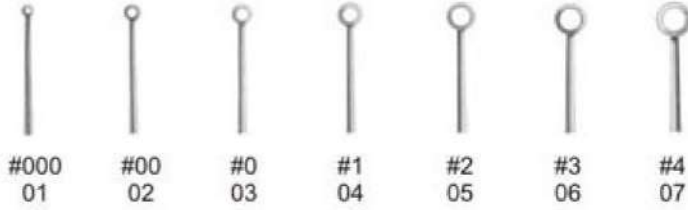

Day
10-055-01 - 10-055-02
16.5 cm / 6 1/2"

10-055-01

10-055-02



Buck
10-056-01 - 10-056-14
16.5 cm / 6 1/2"



Blunt



Sharp



ENT INSTRUMENTS

Ear Knives



Buck
10-057-15
15 cm / 6"



Politzer
10-058-16
16 cm / 6½"



Sexton
10-059-18
18 cm / 7¼"

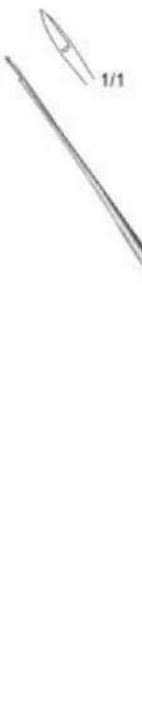

Sexton
10-060-17
17 cm / 6¾"



Gerzog-Sexton
10-061-17
17 cm / 6¾"



Politzer
10-062-16
16 cm / 6½"



Politzer
10-063-16
16.5 cm / 6½"



Politzer
10-064-16
16.5 cm / 6½"



Lucae
10-065-18
18 cm / 7¼"



Lucae
10-066-18
18 cm / 7¼"





Metal-Alloy
10-067-10
c128



Metal-Alloy
10-068-11
c256



Metal-Alloy
10-069-12
c512



Metal-Alloy
10-070-13
c1024



Metal-Alloy
10-071-14
c2048



10-072-00



Tuning Fork Set of 5
10-073-00



ENT INSTRUMENTS

Ear Forceps

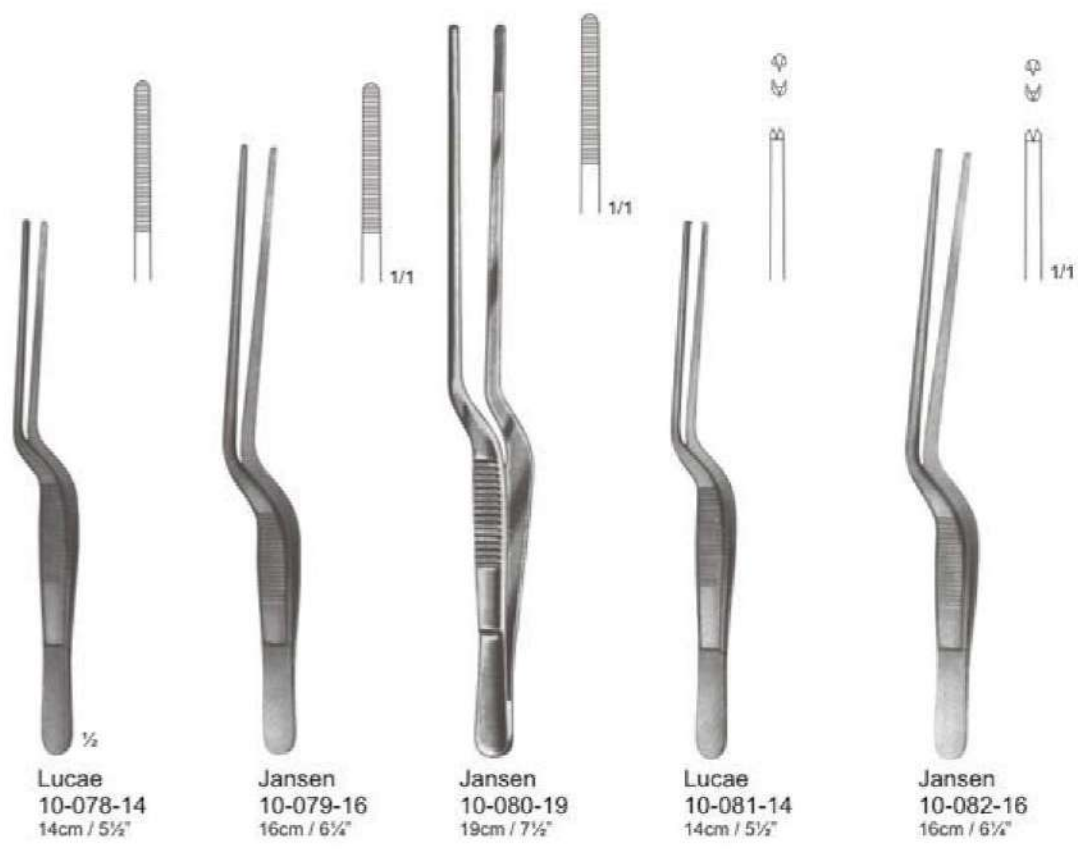

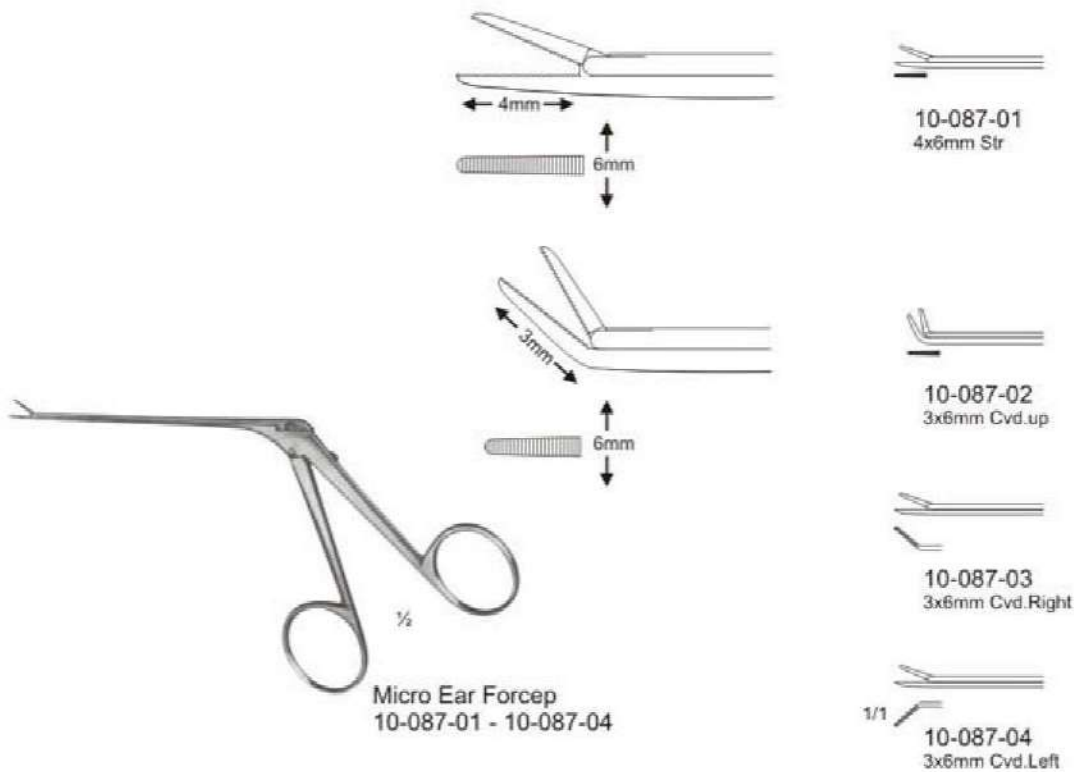
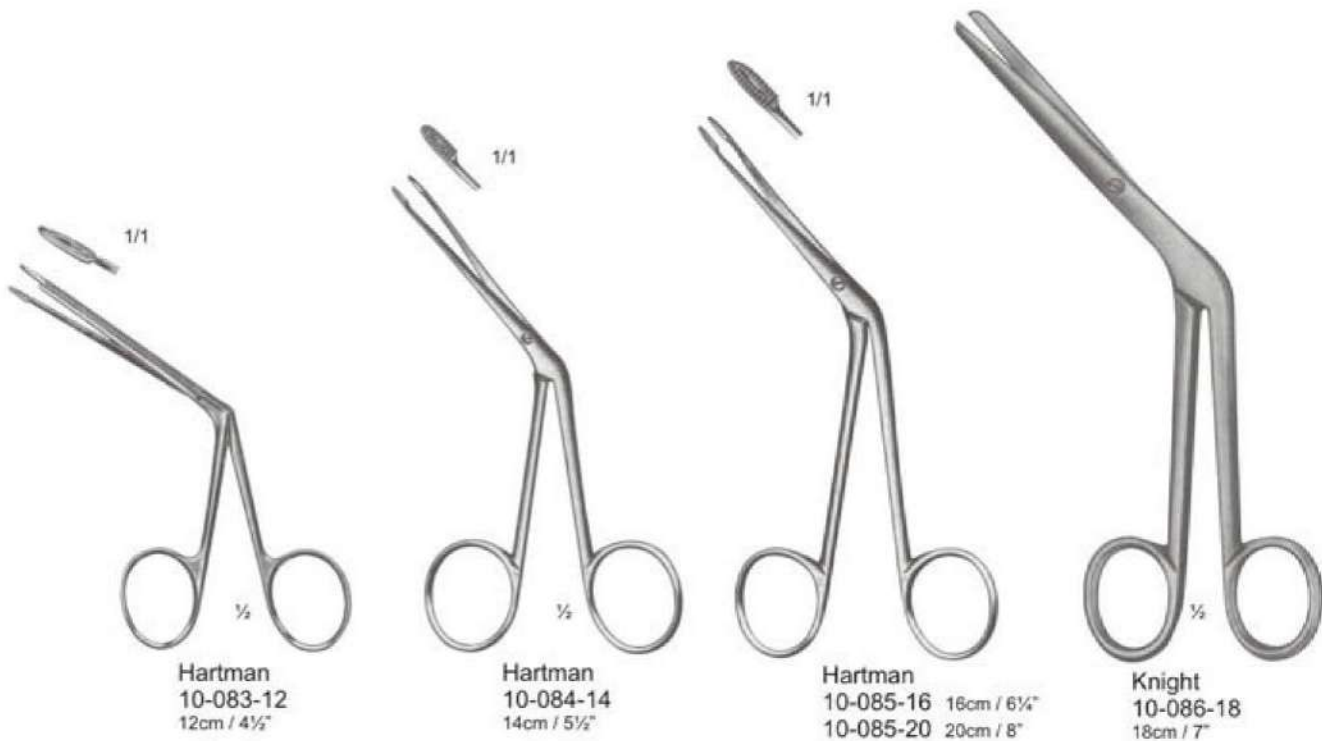

ENT INSTRUMENTS

Micro Ear Forceps

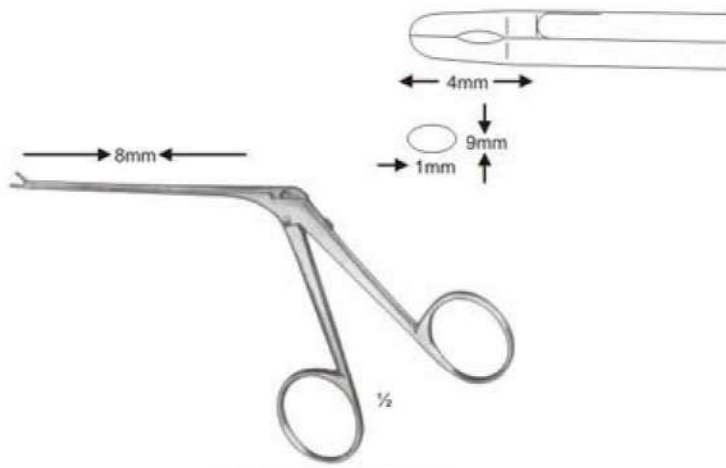

10-088-01 - 10-088-04
8cm / 3 1/4"

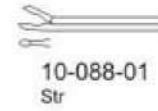

10-088-01
Str



10-088-02
Cvd up



10-088-03
Right Cvd



10-088-04
Left Cvd

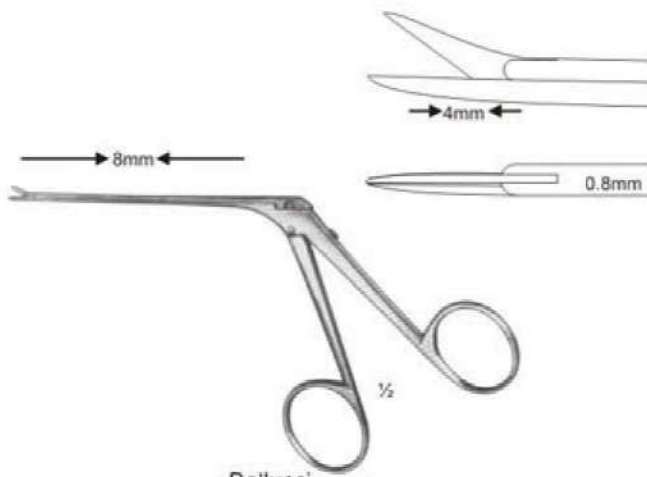

Bellucci
10-089-01 - 10-089-04
8cm / 3 1/4"

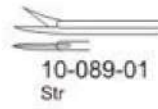

10-089-01
Str



10-089-02
Cvd up



10-089-03
Right Cvd



10-089-04
Left Cvd

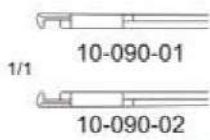
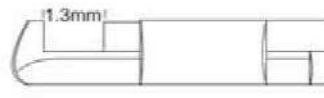

10-090-01
10-090-02



House-Dieter
10-090-01 - 10-090-02
8cm / 3 1/4"

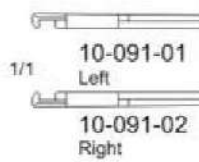

10-091-01
Left
10-091-02
Right



House-Dieter
10-091-01 - 10-091-02
8cm / 3 1/4"



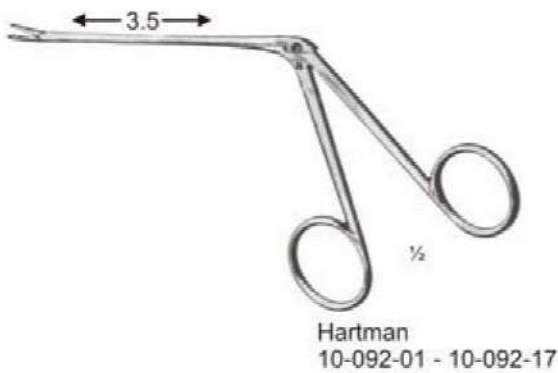
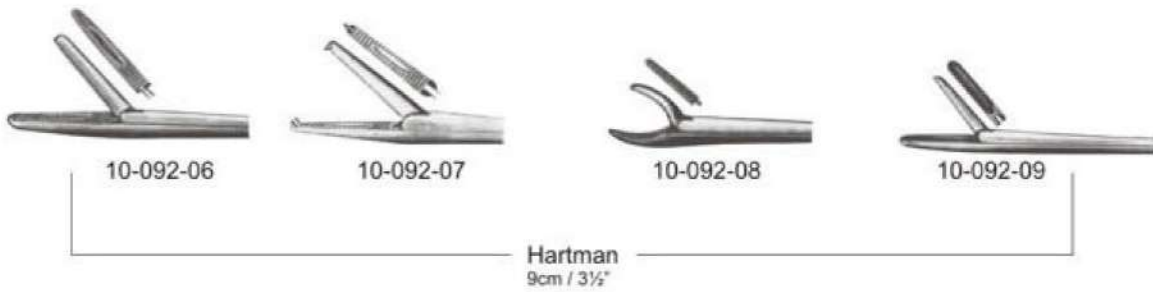
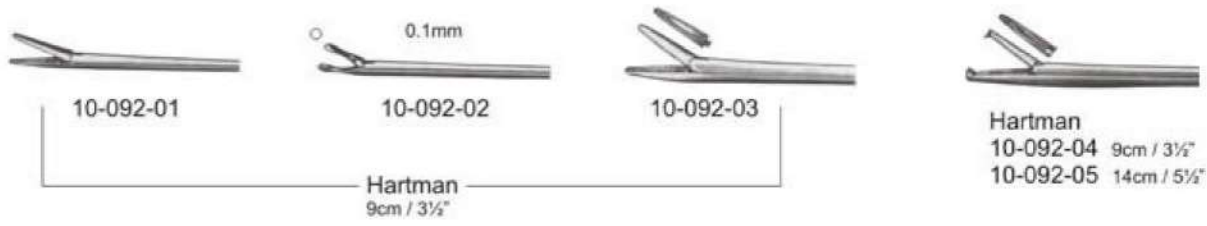

ENT INSTRUMENTS

Micro Ear Forceps



1/1

Randall
10-093-10
240mm / 9 3/4"



1/2

Ochsner
10-094-01 Ø4.5mm
10-094-02 Ø5.5mm
10-094-03 Ø6.5mm
10-094-04 Ø7.5mm



1/1

10-095-02 Ø2mm
10-095-03 Ø3mm
10-095-04 Ø4mm

→ Luer Lock

Novak-Schoeckaert
10-095-02 - 10-095-04
240mm / 9 3/8"



10-096-01 #1
10-096-02 #2
10-096-03 #3
10-096-04 #4



1/2

Adson Str
10-097-01
21cm / 8 1/4"



1/2

Adson Cvd
10-097-02
21cm / 8 1/4"



Frazier Str
10-097-06 Fr.
10-097-07 Fr.
10-097-08 Fr.
10-097-09 Fr.
10-097-10 Fr.
10-097-11 Fr.
10-097-12 Fr.
13cm / 5"



Frazier Cvd
10-098-06 Fr.
10-098-07 Fr.
10-098-08 Fr.
10-098-09 Fr.
10-098-10 Fr.
10-098-11 Fr.
10-098-12 Fr.
13cm / 5"



Fergusson
10-099-06 Fr.
10-099-07 Fr.
10-099-08 Fr.
10-099-09 Fr.
10-099-10 Fr.
10-099-11 Fr.
10-099-12 Fr.
13cm / 5"

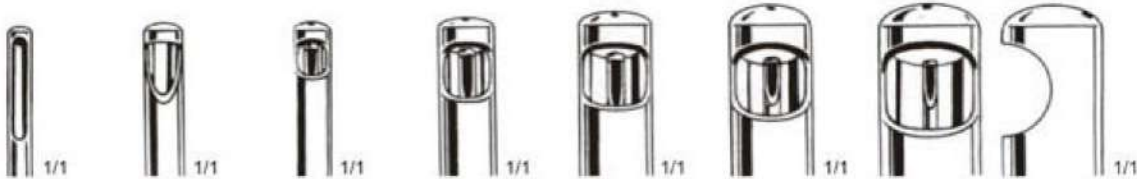

10-100-01
28cm / 11"
4mm

10-100-02
28cm / 11"
3mm

10-100-03
28cm / 11"
4.5mm

10-100-04
28cm / 11"
6mm

10-100-05
28cm / 11"
8mm

10-100-06
28cm / 11"
10mm

10-100-07
28cm / 11"
14mm

10-100-08
10cm / 4"
10mm

ENT INSTRUMENTS

Suction Tubes

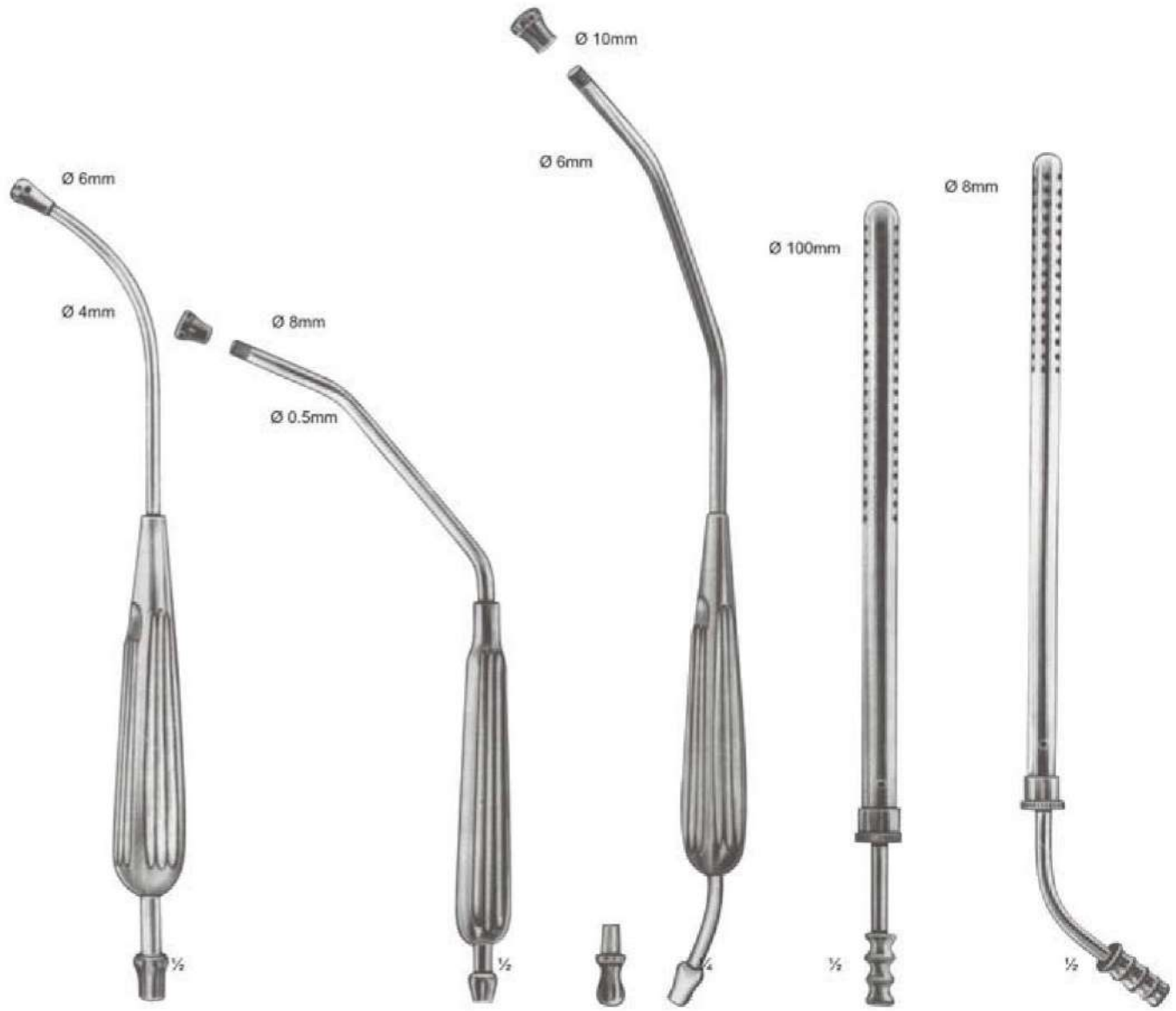
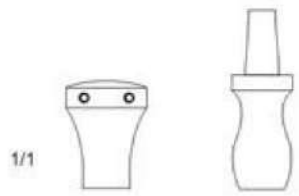

Andrew Pynchon
10-101-24
24cm / 9 1/2"

Yankaur Child
10-102-21
21cm / 8 1/4"

Yankaur
10-103-29
29cm / 11 1/2"

Poole
10-104-24
24cm / 9 1/4"

Poole
10-105-25
25cm / 10"





1/1

10-106-01
1mm
29cm / 11¼"



10-107-02
2mm
29cm / 11¼"



10-108-03
21cm / 8¼"
10-109-03
29cm / 11¼"
3mm



10-110-04
21cm / 8¼"
10-111-04
29cm / 11¼"
4mm



10-112-05
21cm / 8¼"
10-113-05
29cm / 11¼"
5mm



10-114-06
21cm / 8¼"
10-115-06
29cm / 11¼"
6mm



10-116-07
21cm / 8¼"
10-117-07
29cm / 11¼"
7mm

1/1

10-118-08
21cm / 8¼"
10-119-08
29cm / 11¼"
8mm



10-120-09
21cm / 8¼"
10-121-09
29cm / 11¼"
9mm



10-122-10
21cm / 8¼"
10-123-10
29cm / 11¼"
10mm



10-124-10
21cm / 8¼"
10-125-10
29cm / 11¼"
11mm



10-126-12
21cm / 8¼"
10-127-12
29cm / 11¼"
12mm



10-128-13
21cm / 8¼"
10-129-13
29cm / 11¼"
13mm

Bakes

10-106-01 - 10-126-13
21cm / 8¼"



10-130-11 11cm / 4½"
10-130-13 13cm / 5"
10-130-14 14cm / 5½"
10-130-15 15cm / 6"
10-130-18 18cm / 7"
10-130-20 20cm / 8"



10-131-11 11cm / 4½"
10-131-13 13cm / 5"
10-131-14 14cm / 5½"
10-131-15 15cm / 6"
10-131-18 18cm / 7"
10-131-20 20cm / 8"



10-132-11 11cm / 4½"
10-132-13 13cm / 5"
10-132-14 14cm / 5½"
10-132-15 15cm / 6"
10-132-18 18cm / 7"
10-132-20 20cm / 8"



10-133-11 11cm / 4½"
10-133-13 13cm / 5"
10-133-14 14cm / 5½"
10-133-15 15cm / 6"
10-133-18 18cm / 7"
10-133-20 20cm / 8"



ENT INSTRUMENTS

Probes



- 10-134-11 11cm / 4½"
- 10-134-13 13cm / 5"
- 10-134-14 14cm / 5½"
- 10-134-15 15cm / 6"
- 10-134-18 18cm / 7"
- 10-134-20 20cm / 8"
- 10-134-23 23cm / 9"
- 10-134-25 25cm / 10"



- 10-135-11 11cm / 4½"
- 10-135-13 13cm / 5"
- 10-135-14 14cm / 5½"
- 10-135-15 15cm / 6"
- 10-135-18 18cm / 7"
- 10-135-20 20cm / 8"
- 10-135-23 23cm / 9"
- 10-135-25 25cm / 10"



- 10-136-11 11cm / 4½"
- 10-136-13 13cm / 5"
- 10-136-14 14cm / 5½"
- 10-136-15 15cm / 6"
- 10-136-18 18cm / 7"
- 10-136-20 20cm / 8"
- 10-136-23 23cm / 9"
- 10-136-25 25cm / 10"



- 10-137-11 11cm / 4½"
- 10-137-13 13cm / 5"
- 10-137-14 14cm / 5½"
- 10-137-15 15cm / 6"
- 10-137-18 18cm / 7"
- 10-137-20 20cm / 8"
- 10-137-23 23cm / 9"
- 10-137-25 25cm / 10"



- 10-138-11 11cm / 4½"
- 10-138-13 13cm / 5"
- 10-138-14 14cm / 5½"
- 10-138-15 15cm / 6"
- 10-138-18 18cm / 7"
- 10-138-20 20cm / 8"
- 10-138-23 23cm / 9"
- 10-138-25 25cm / 10"



- 10-139-11 11cm / 4½"
- 10-139-13 13cm / 5"
- 10-139-14 14cm / 5½"
- 10-139-15 15cm / 6"
- 10-139-18 18cm / 7"
- 10-139-20 20cm / 8"
- 10-139-23 23cm / 9"
- 10-139-25 25cm / 10"



- 10-140-11 11cm / 4½"
- 10-140-13 13cm / 5"
- 10-140-14 14cm / 5½"
- 10-140-15 15cm / 6"
- 10-140-18 18cm / 7"
- 10-140-20 20cm / 8"
- 10-140-23 23cm / 9"
- 10-140-25 25cm / 10"



BOWLS & TRAYS

07



Instruments Bowls & Trays



FIVE S SURGICAL

Sponge Bowls & Tray



Emesis or Pus Basin

14-001-00 200mm
14-001-01 250mm



Sponge Bowl

14-002-00 Ø45x25mm
14-002-01 Ø55x30mm
14-002-02 Ø75x35mm
14-002-03 Ø80x40mm
14-002-04 Ø90x45mm
14-002-05 Ø105x50mm
14-002-06 Ø125x55mm
14-002-07 Ø145x60mm
14-002-08 Ø165x70mm



Instrument Tray

14-003-00 Ø230x130x45mm
14-003-01 Ø260x170x50mm
14-003-02 Ø320x200x50mm
14-003-03 Ø415x250x65mm
14-003-04 Ø510x325x55mm



**Perforated
Sterilization Tray**

14-004-00 Ø230x130x45mm
14-004-01 Ø260x170x50mm
14-004-02 Ø320x200x50mm
14-004-03 Ø415x250x65mm
14-004-04 Ø510x325x55mm





Needle or Ointment jar
 14-005-00 Ø75x60mm
 14-005-01 Ø90x50mm



Perforated Sterilization Tray

	W	L	H
14-006-00	228	128	50mm
14-006-01	253	163	50mm
14-006-02	315	197	55mm
14-006-03	417	252	65mm
14-006-04	512	327	65mm



Instruments Tray Without lid

	W	L	H
14-007-00	215	175	25mm
14-007-01	250	200	40mm
14-007-02	280	200	50mm
14-007-03	360	320	60mm
14-007-04	530	430	80mm



Perforated Instruments Tray

	W	L	H
14-008-00	215	175	25mm
14-008-01	250	200	40mm
14-008-02	280	200	50mm
14-008-03	360	320	60mm
14-008-04	530	430	80mm



Sponge Bowls & Tray



Dressing Jar

14-009-00	Ø 85 x 90 mm
14-009-01	Ø 115 x 120 mm
14-009-02	Ø 140 x 140 mm
14-009-03	Ø 170 x 170 mm

Instrument Tray
with strap handle lid

14-010-00	230 x 130 x 45 mm
14-010-01	260 x 170 x 50 mm
14-010-02	320 x 200 x 55 mm
14-010-03	370 x 270 x 75 mm

Instrument Tray
with recessed handle Lid

14-011-00	265 x 165 x 63 mm
14-011-01	325 x 175 x 63 mm
14-011-02	325 x 265 x 63 mm
14-011-03	530 x 325 x 63 mm



Dressing Package tray

	W x L x H
14-012-00	140 x 230 x 30mm

Catheter tray with
strap handle lid

	W x L x H
14-013-00	450 x 120 x 60 mm (Large)
14-013-01	220 x 80 x 35 mm (Small)



Forcep jar
 14-014-00 Ø 55 x 110 mm
 14-014-01 Ø 50 x 130 mm
 14-014-02 Ø 55 x 160 mm
 14-014-03 Ø 76 x 200 mm
 14-014-04 Ø 100 x 180 mm



Sterilizing Drum
 14-015-00 Ø 150 mm
 14-015-01 Ø 180 mm
 14-015-02 Ø 250 mm
 14-015-03 Ø 270 mm



Solution bowl
 14-016-00 Ø 305 x 105 mm
 14-016-01 Ø 310 x 110 mm
 14-016-02 Ø 345 x 115 mm
 14-016-03 Ø 370 x 120 mm



Wash basin
 14-017-00 Ø 350 x 110 mm



Sponge Bowls & Tray



Enema can
14-018-00 \varnothing 120 x 170 mm



Micro Tray
Complete
14-019-00



Insert Only
14-020-00



Micro Tray
14-021-00



Micro Instruments Tray
14-022-20 200 x 100 x 25 mm
14-023-23 230 x 130 x 25 mm
14-024-27 275 x 230 x 25 mm



PLASTIC SURGERY

08

Plastic Surgery Instruments

INSTRUMENTS OF THIS
CENTURY

OPHTHALMIC SURGERY INSTRUMENTS

Rhino Plastic Forceps & Scissors

Inches



Rubin
07-004-21
21 cm / 8.5"



Cottle Kazanjian
07-005-19
19 cm / 7 1/2"

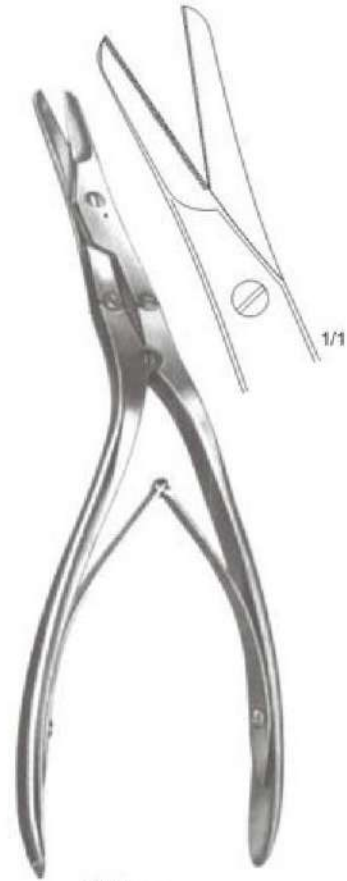

Calpan
07-006-20
20 cm / 8"



Gorney
07-007-12 - 07-008-09



07-007-12
12.5 cm / 5"



07-007-19
19.5 cm / 7 1/2"



07-008-19
19.5 cm / 7 1/2"



PLASTIC SURGERY INSTRUMENTS

Delicate Scissors

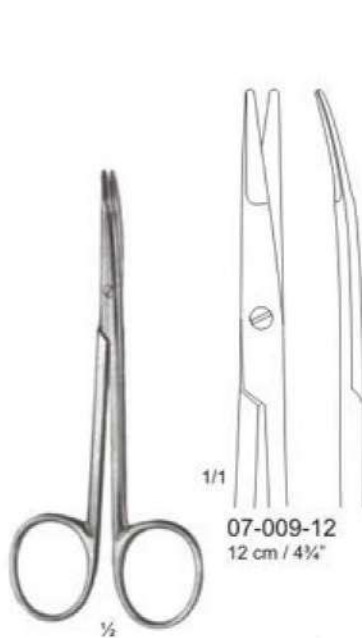

07-009-12
12 cm / 4 3/4"

Kilner
07-009-12 - 07-009-15

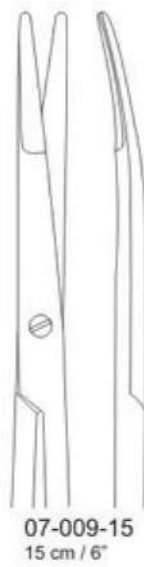

07-009-15
15 cm / 6"

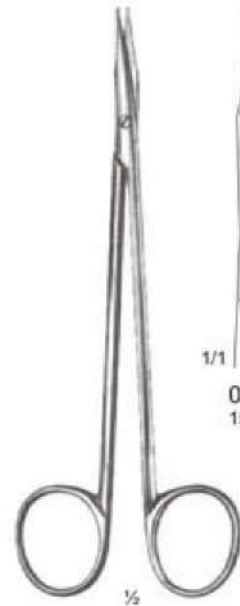

07-010-15
15 cm / 6"

Reynolds SC
07-010-15 - 07-111-15



07-011-15
15 cm / 6"



Fomon SC
07-012-15
15 cm / 6"



Cottle
07-013-16
16 cm / 6 1/2"



Heymann-Knight
07-014-18
18 cm / 7"

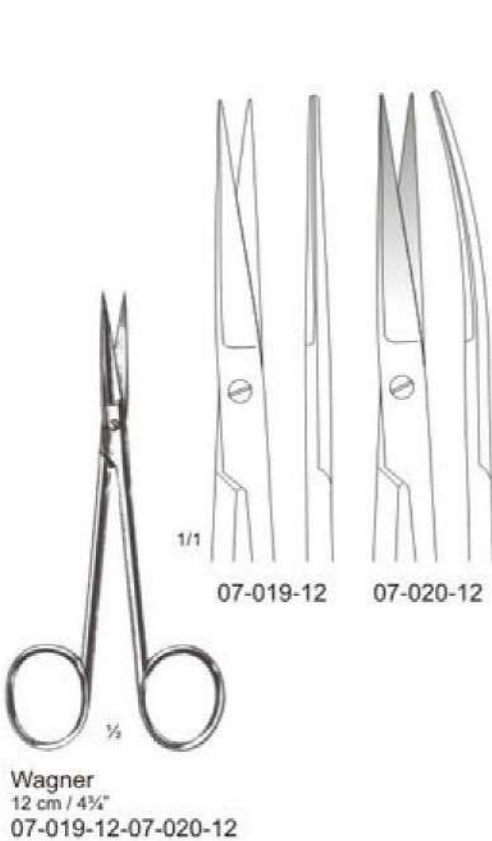
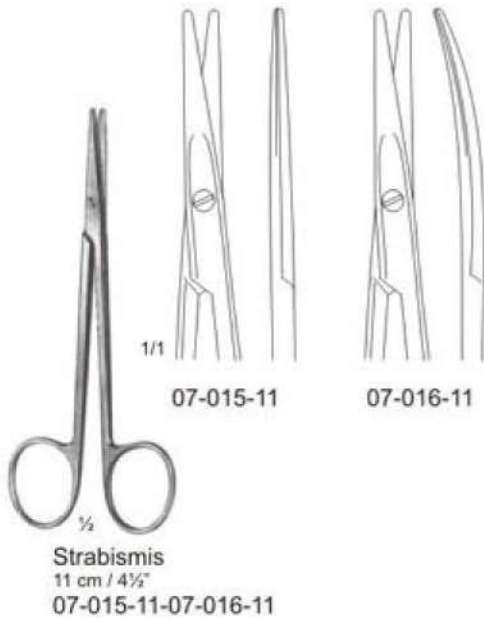

PLASTIC SURGERY INSTRUMENTS

Delicate Scissors



Quinby
07-023-12
12.5 cm / 4 1/4"

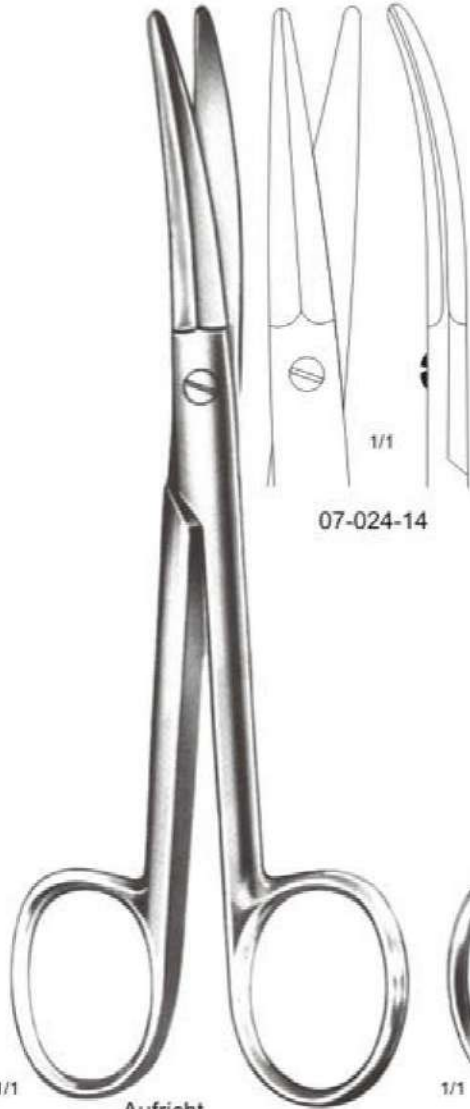

07-024-14

1/1
Aufricht
14.5 cm / 5 3/4"

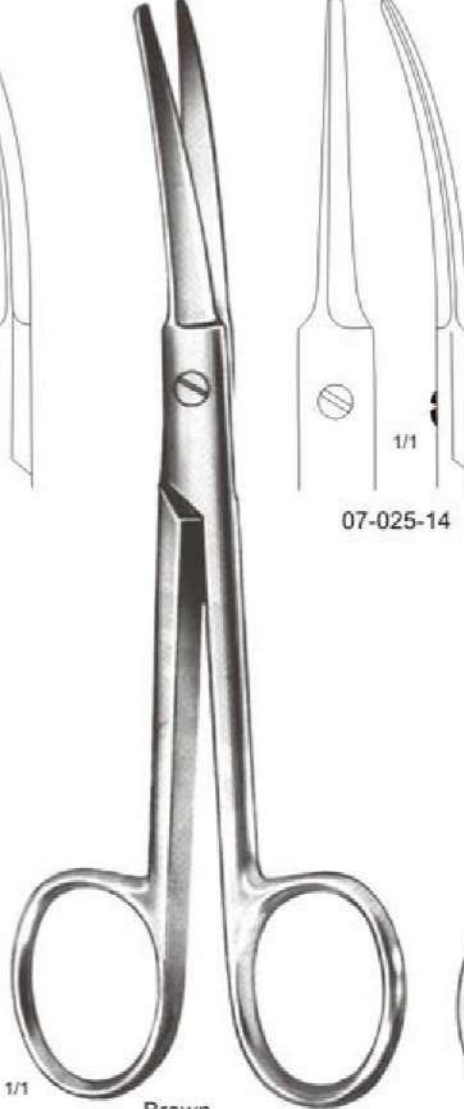

07-025-14

1/1
Brown
14.5 cm / 5 3/4"

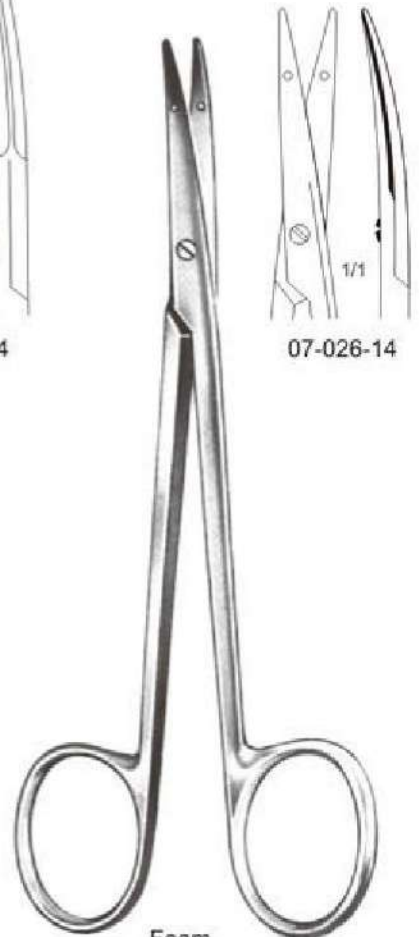

07-026-14

1/1
Foam
14.5 cm / 5"



07-027-15 07-028-15 07-029-15 07-030-15

Joseph
15 cm / 6"
07-027-15 - 07-030-15

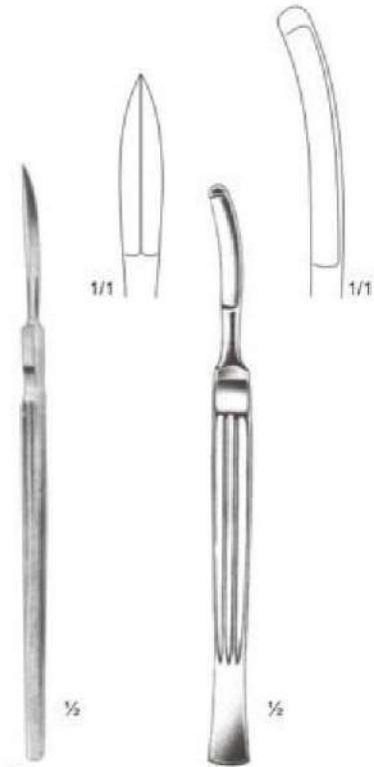

Fomon
07-031-16
16 cm / 6 1/2"
Converse
07-032-16
16 cm / 6 1/2"

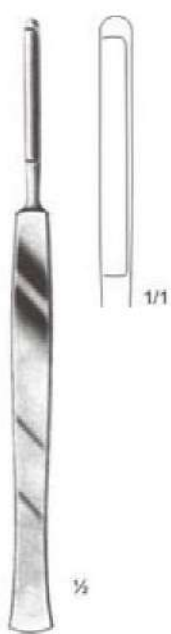

Joseph
07-033-15
15 cm / 6"



Joseph
07-034-15
15 cm / 6"

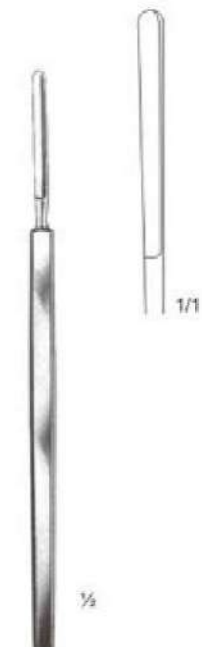

07-035-15



PLASTIC SURGERY INSTRUMENTS

Skin Hooks



Lange
07-036-22
21 cm / 8 1/4"



Joseph
07-037-16
16 cm / 6 1/4"



Joseph
07-037-02 - 07-037-10
16 cm / 6 1/4"

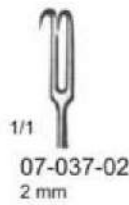

1/1
07-037-02
2 mm



1/1
07-037-05
5 mm



1/1
07-037-07
7 mm



1/1
07-037-10
10 mm



Kleinert
07-038-01 - 07-038-13
16 cm / 6 1/4"



1/1
07-038-01



07-038-02



1/1
07-038-03



07-039-01 - 07-039-04
14 cm / 5 1/2"



1/1
07-039-01



07-039-02



1/1
07-039-03



07-039-04



Lahey
07-040-01 - 07-040-03
12.5 cm / 4 1/4"



1/1
07-040-01



1/1
07-040-02



1/1
07-040-03



07-040-04
12.5 cm / 4 1/4"



1/1
Blunt



1/1



Converse
07-041-18
18 cm / 7"



Converse
07-042-18
18 cm / 7"



Gillies
07-043-18
18 cm / 7"



Kilner
07-044-15
15 cm / 6"



Converse
07-045-12
12.5 cm / 4 1/2"



Lange
07-046-17
17 cm / 6 1/2"



Fomon
07-047-16
16 cm / 6 1/4"



Miller
13.5 cm / 5 1/4"



PLASTIC SURGERY INSTRUMENTS

Bone Files & Rasps



Ragnell
07-049-15
15 cm / 6"



Aufricht
07-050-45 mm (L)
07-050-60 mm (L)



Aufricht
21 cm / 8 1/2"



Forward
07-051-21



Backward
07-052-21

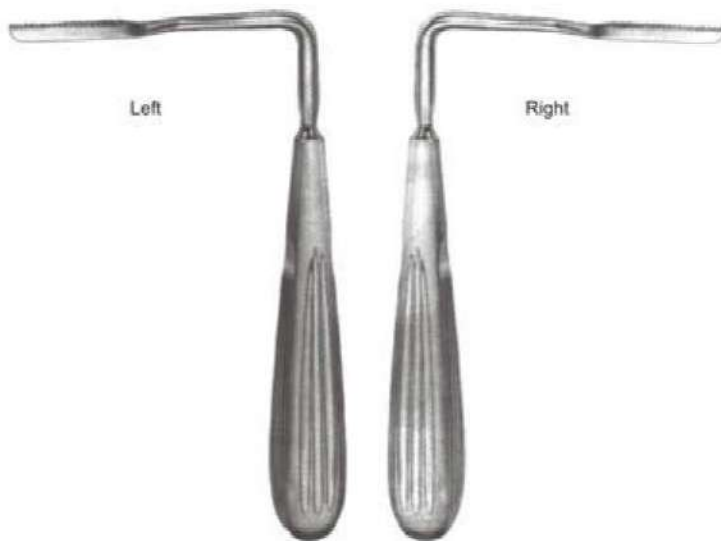

Joseph
07-053-17
17 cm / 6 1/2"

Joseph
07-054-17
17 cm / 6 1/2"



Lewis
07-055-18 - 07-056-18
18 cm / 7"



07-055-18
Fine



07-056-18
Standard



Fomon
07-057-22
22 cm / 8 3/4"

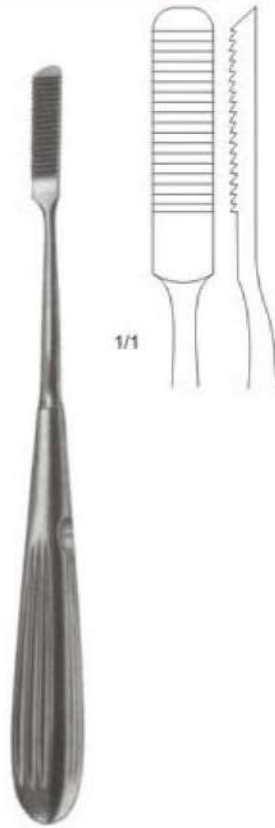

Cottle
07-058-21
21 cm / 8 1/4"

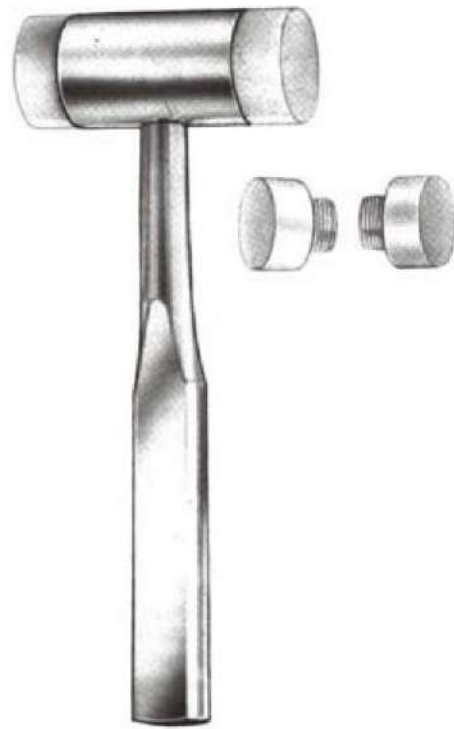

Medro-Mallet
07-059-19
19 cm / 7 1/2"



Medro-Mallet
07-060-19
19 cm / 7 1/2"



Mead
07-061-17
17 cm / 6 3/4"



Partch
07-062-18
18 cm / 7"



PLASTIC SURGERY INSTRUMENTS

Gigli Saw



Gigli
 07-064-30 - 30 cm / 12"
 07-064-40 - 40 cm / 16"
 07-064-50 - 50 cm / 20"
 07-064-60 - 60 cm / 24"
 07-064-70 - 70 cm / 28"

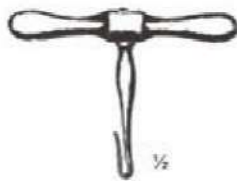

Gigli
 07-065-06
 6 cm / 2 1/4"

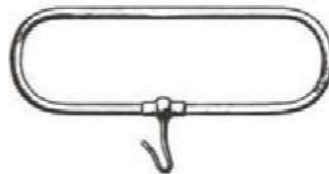

07-066-06



Crutchfield
 07-067-01 Small
 07-068-02 Medium
 07-069-03 Large



ORTHOPEDIC

09

Orthopedic Instruments

INSTRUMENTS OF THIS
CENTURY

ORTHOPEDIC INSTRUMENTS

Rib Shears



Giertz - Stille
12-001-27
27cm / 10½"

1/3



12-002-20
20cm / 8"

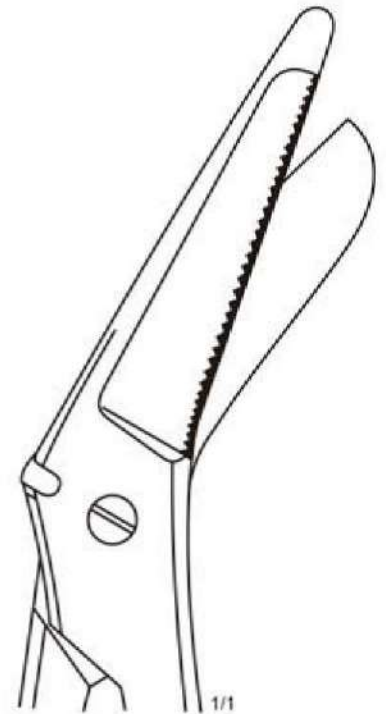

1/1



12-003-22
22cm / 8¾"

¼



Gluck
12-004-22
22cm / 8¾"

¼



Wolff
12-005-18 - 12-005-24

¼



1/1

12-005-18
18cm / 7"



12-005-24
24cm / 9½"



Henning
12-006-28
28cm / 11"

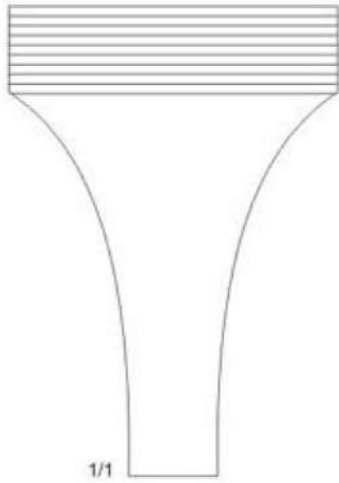

Lewin
12-006-18
18cm / 7"

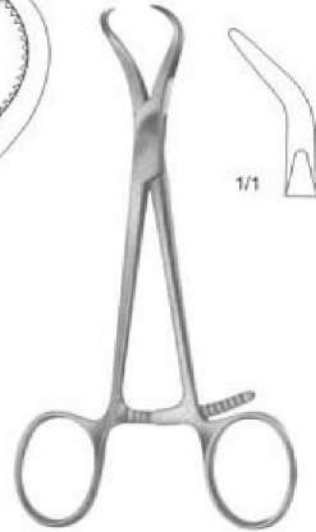
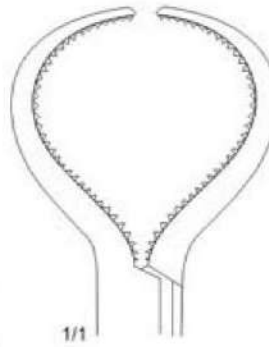

Finger Reposition Forceps
12-006-13
13cm / 5 1/4"



Finger Reposition Forceps
12-006-14
13cm / 5 1/4"



REILL Reposition Forceps
12-007-17
17cm / 6 1/2"



Bone Reposition Forceps
12-008-20
20cm / 8"



ORTHOPEDIC INSTRUMENTS

Bone Holding Clamps & Forceps



Lowman Modif
 12-009-12 12cm / 4¾"
 12-009-18 18cm / 7"
 12-009-20 20cm / 8"
 12-009-22 22cm / 8¾"



Lowman
 12-010-18
 18cm / 7"



Lowman
 12-011-12 12cm / 4¾"
 12-011-18 18cm / 7"
 12-011-20 20cm / 8"



Kern Without Ratchet
 12-012-14 - 12-013-22



1/1
 12-012-14 14cm / 5½"
 12-013-22 22cm / 8¾"



Kern Without Ratchet
 12-014-14 14cm / 5½"
 12-014-22 22cm / 8¾"



1/1
 12-014-33 33cm / 13"
 12-014-43 43cm / 17"
 12-014-33 33cm / 13"
 12-014-43 43cm / 17"



Lane Without Ratchet
 12-014-33 - 12-014-43
Lane With Ratchet
 12-015-33 - 12-015-43



12-016-23
23cm / 9"



12-017-25
25cm / 10"

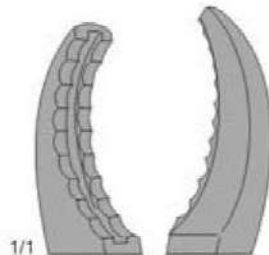

12-018-28
28cm / 11"

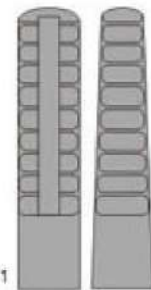

12-019-23 23cm / 9"
12-020-26 26cm / 10"
12-021-28 28cm / 11"



Ulrich str.
12-016-23 - 12-018-28

Ulrich Cvd.
12-019-23 - 12-021-28

ORTHOPEDIC INSTRUMENTS

Bone Holding Clamps & Forceps



Farabeuf-Lambotte Forceps
12-022-25
25cm / 10"



Farabeuf Forceps
12-023-25
25cm / 10"



Farabeuf Forceps
12-024-23
23cm / 9"



Verbrugge
12-025-25 - 12-027-27



12-025-25
25cm / 10"



12-026-26
26cm / 10"



12-027-27
27cm / 10 1/2"



12-028-18
18cm / 7"



Verbrugge
12-028-18

With Lip Joint

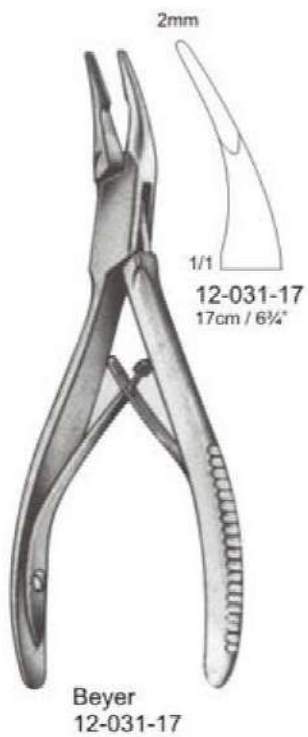
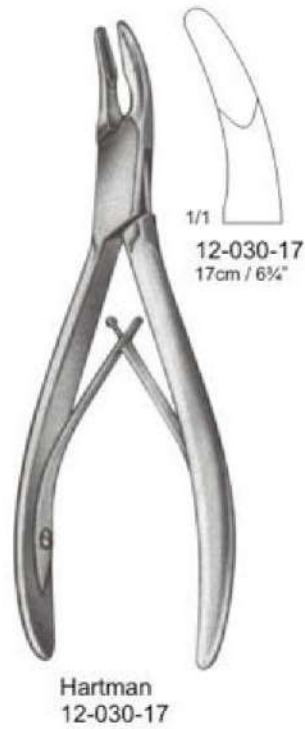
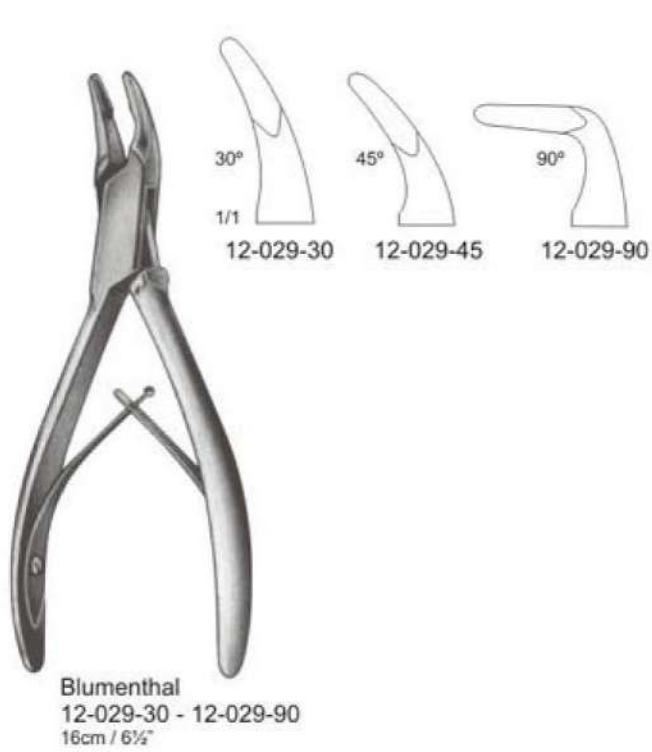

ORTHOPEDIC INSTRUMENTS

Single Action Rongeurs



Luer
12-033-01 - 12-033-03
15cm / 6"



1/1
12-033-01



12-033-02



12-033-03



Lempert
12-034-19
19cm / 7 1/2"



1/1



Luer
12-035-18
18cm / 7"



1/1

8mm



Luer
12-036-18
18cm / 7"



1/1

8mm



Adson
12-037-20
20cm / 8"



1/1



Ruskin Mini
12-038-01 - 12-038-03
15cm / 6"



Ruskin-Ruskin
12-039-24
24cm / 9 1/2"



Beyer
12-040-18
18cm / 7"



Zaufal-Jansen
12-041-18
18cm / 7"



Ruskin
12-042-18 - 12-043-18



ORTHOPEDIC INSTRUMENTS

Double Action Rongeurs



Stille
12-044-21 - 12-045-26



10mm

1/1

12-044-21
21cm / 8 3/4"
Str.



10mm

12-045-21
21cm / 8 3/4"
Curved.



17mm

12-044-26
26cm / 10 1/4"
Str.



17mm

12-045-26
26cm / 10 1/4"
Curved.



Stille-Luer (Duckbill)
12-046-23
23cm / 9"



1/1

6x5mm



Echlin (Duckbill)
12-047-01 - 12-047-03



1/1

12-047-01
23cm / 9"
2x10mm



12-047-02
23cm / 9"
3x10mm



12-047-03
23cm / 9"
4x10mm



Str.



- 12-048-03 (19 cm / 7½" - 3mm bite)
- 12-049-03 (19 cm / 7½" - 4mm bite)
- 12-050-03 (24 cm / 9½" - 3mm bite)
- 12-051-03 (24 cm / 9½" - 4mm bite)



Half Curved

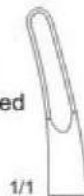

- 12-052-03 (19 cm / 7½" - 3mm bite)
- 12-053-03 (19 cm / 7½" - 4mm bite)
- 12-054-03 (24 cm / 9½" - 3mm bite)
- 12-055-03 (24 cm / 9½" - 4mm bite)



Full Curved

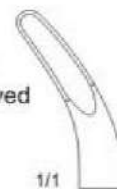

- 12-056-03 (19 cm / 7½" - 3mm bite)
- 12-057-03 (19 cm / 7½" - 4mm bite)
- 12-058-03 (24 cm / 9½" - 3mm bite)
- 12-059-03 (24 cm / 9½" - 4mm bite)



ORTHOPEDIC INSTRUMENTS

Double Action Rongeurs

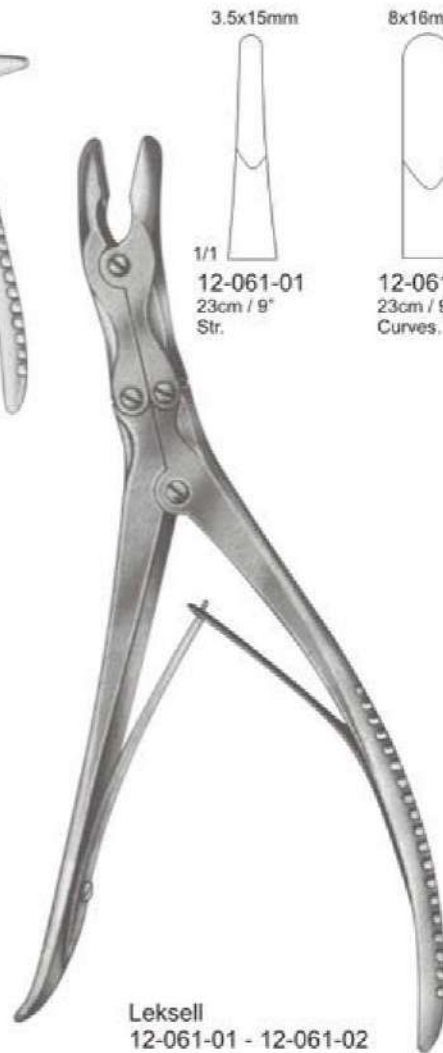

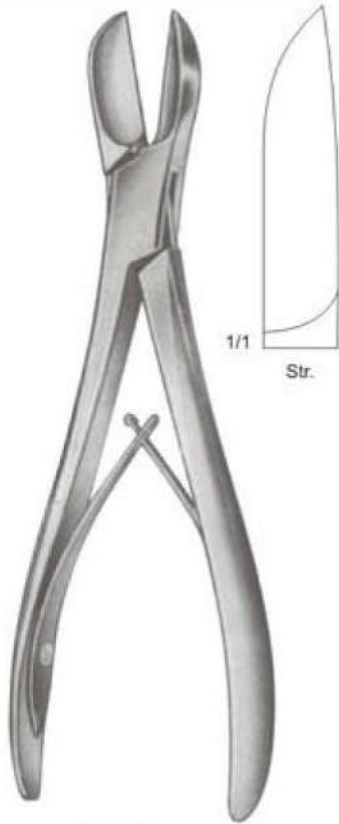

Liston
 12-063-14 14 cm / 5½"
 12-063-17 17 cm / 6¾"
 12-063-19 19 cm / 7½"
 12-063-22 22 cm / 8¾"

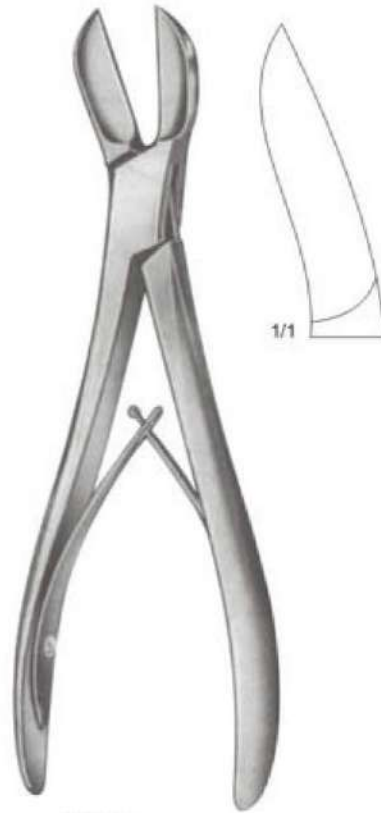

Liston
 12-064-14 14 cm / 5½"
 12-064-17 17 cm / 6¾"
 12-064-19 19 cm / 7½"
 12-064-22 22 cm / 8¾"

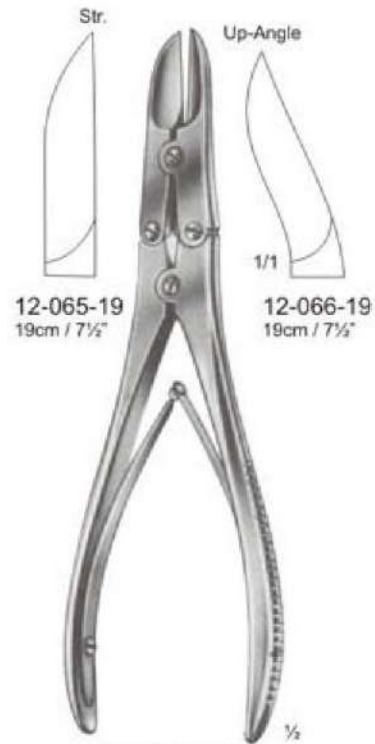

Ruskin-Liston
 12-065-19 - 12-066-19



Bohler
 12-067-15 - 12-068-15



Stille-Horsley
 12-069-27
 27 cm / 10¾"

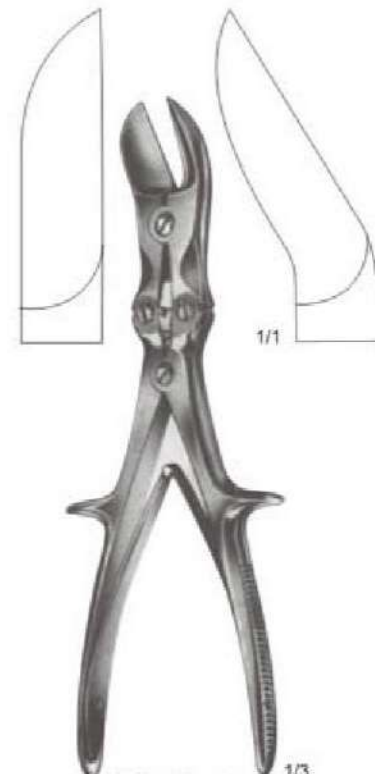

Stille-Horsley
 12-070-26
 26 cm / 10¼"



ORTHOPEDIC INSTRUMENTS

Bone Cutting & Wire Traction Bows



Stille-Liston
12-071-26
26cm / 10 3/4"



Semb
12-071-23
23cm / 9"



Steinmann Traction Bow
12-072-01 90x90 mm
12-072-02 110x210 mm
12-072-03 150x210 mm
A B



	A	B
12-073-01	max 105mm	80 - 95mm
12-073-02	max 160mm	90 - 120mm
12-073-03	max 200mm	440 - 170mm

Kirschner
Wire traction bows, modified,
adjustable in width, holds wire
securely & surely, with 1 hook



12-074-01
Traction hook
Large



12-074-02
Traction hook
Small

ORTHOPEDIC INSTRUMENTS

Raspatories & Bone Hooks

Inches



Doyen
12-075-18 - 12-076-18

Doyen
12-077-18 - 12-078-18



Doyen
12-079-23

Doyen
12-080-23

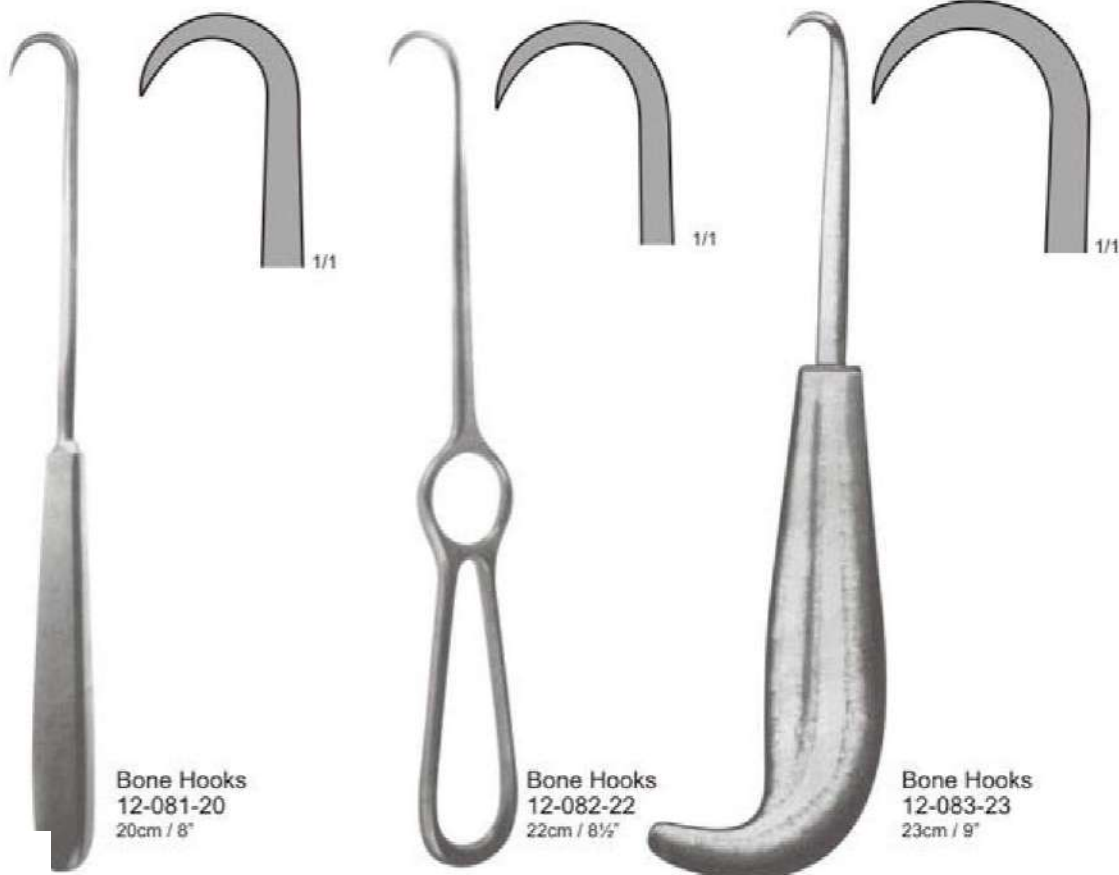

Bone Hooks
12-081-20
20cm / 8"

Bone Hooks
12-082-22
22cm / 8½"

Bone Hooks
12-083-23
23cm / 9"



ORTHOPEDIC INSTRUMENTS

Raspatories Elevators



Labsche
12-084-24
24.5cm / 9 1/2"



Cushing
12-085-18 18.0 cm / 7"
12-086-20 20 cm / 8"
12-087-20 21.0 cm / 8 1/2"



Cushing (Square)
12-088-19
19.0 cm / 7 1/2"



Cushing (Round)
12-089-19
19.0 cm / 7 1/2"



Crego
12-090-01 - 12-090-03
20 cm / 8"

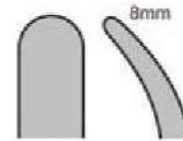

12-090-01

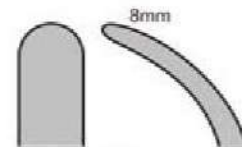

12-090-02

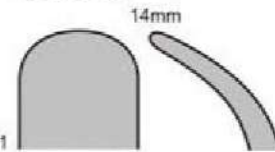

12-090-03



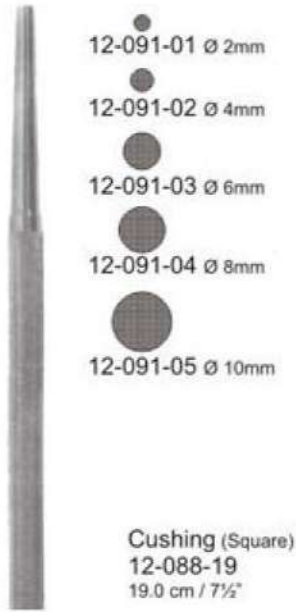

12-091-01 - 12-091-05



Caspar
 12-092-01 - 12-092-06
 With artificial wood handle



12-093-24
 24cm / 9½"



12-094-24
 24cm / 9½"



12-095-22
 22cm / 8"



12-096-24
 24.5cm / 9½"



12-097-24
 24.5cm / 9½"



12-098-24
 24.5cm / 9½"

4/10



ORTHOPEDIC INSTRUMENTS

Bone Currettes



Stainless Steel Handle 12-099-17 - 12-108-17
17 cm / 6 3/4"
Volkman (Fiber) 12-099-18 - 12-108-18
17 cm / 6 3/4"

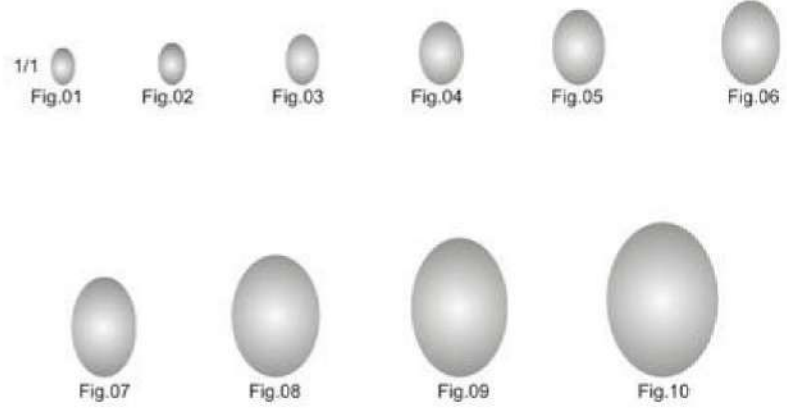

Stainless Handle
12-099-17 (2.8mm) Fig.01 12-104-17 (8.5mm) Fig.06
12-100-17 (3.6mm) Fig.02 12-105-17 (10.0mm) Fig.07
12-101-17 (4.4mm) Fig.03 12-106-17 (11.5mm) Fig.08
12-102-17 (5.2mm) Fig.04 12-107-17 (13.0mm) Fig.09
12-103-17 (6.8mm) Fig.05 12-108-17 (14.5mm) Fig.10

Stainless Handle
12-099-18 (2.8mm) Fig.01 12-104-18 (8.5mm) Fig.06
12-100-18 (3.6mm) Fig.02 12-105-18 (10.0mm) Fig.07
12-101-18 (4.4mm) Fig.03 12-106-18 (11.5mm) Fig.08
12-102-18 (5.2mm) Fig.04 12-107-18 (13.0mm) Fig.09
12-103-18 (6.8mm) Fig.05 12-108-18 (14.5mm) Fig.10

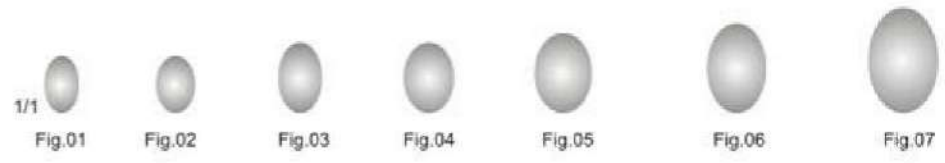

12-110-27 (2.8mm) Fig.01
12-111-27 (3.6mm) Fig.02
12-112-27 (4.4mm) Fig.03
12-113-27 (5.2mm) Fig.04
12-114-27 (6.8mm) Fig.05
12-115-27 (6.8mm) Fig.06
12-116-27 (6.8mm) Fig.07

Volkman (Fiber Handle)
12-110-27 - 12-116-27
27 cm / 10 1/2"



Cobb Fiber Handle
12-117-25 - 12-123-35

- 12-117-25 25cm 10" (10mm)
- 12-118-25 25cm 10" (13mm)
- 12-119-25 25cm 10" (19mm)
- 12-120-25 25cm 10" (25mm)
- 12-121-35 35cm 13 3/4" (10mm)
- 12-122-35 35cm 13 3/4" (13mm)
- 12-123-35 35cm 13 3/4" (19mm)

Cobb Stainless Steel Handle
12-124-25 - 12-130-35

- 12-124-25 25cm 10" (10mm)
- 12-125-25 25cm 10" (13mm)
- 12-126-25 25cm 10" (19mm)
- 12-127-25 25cm 10" (25mm)
- 12-128-35 35cm 13 3/4" (10mm)
- 12-129-35 35cm 13 3/4" (13mm)
- 12-130-35 35cm 13 3/4" (19mm)

ORTHOPEDIC INSTRUMENTS

Gouges



Smith-Peterson
12-131-20 - 12-137-20

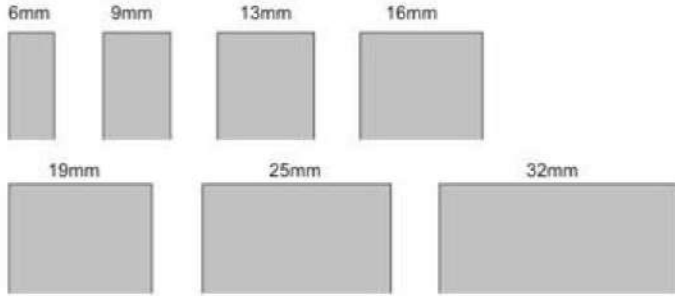

Fiber handle
Please add the symbol "FH" to the
Catalog Numbers

- 12-131-25 20cm / 8" (06mm) Straight
- 12-132-25 20cm / 8" (09mm) Straight
- 12-133-25 20cm / 8" (13mm) Straight
- 12-134-25 20cm / 8" (16mm) Straight
- 12-135-35 20cm / 8" (19mm) Straight
- 12-136-35 20cm / 8" (25mm) Straight
- 12-137-35 20cm / 8" (32mm) Straight



Smith-Peterson
12-138-20 - 12-144-20

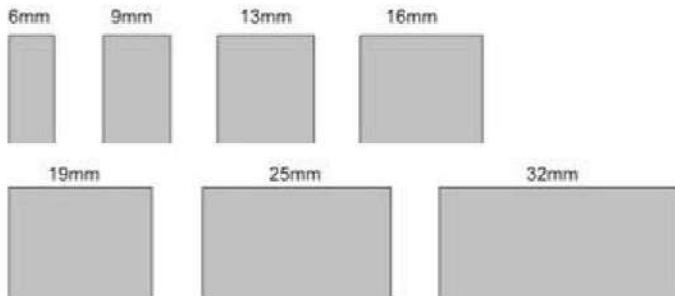

Fiber handle
Please add the symbol "FH" to the
Catalog Numbers

- 12-138-25 20cm / 8" (06mm) Curved
- 12-139-25 20cm / 8" (09mm) Curved
- 12-140-25 20cm / 8" (13mm) Curved
- 12-141-25 20cm / 8" (16mm) Curved
- 12-142-35 20cm / 8" (19mm) Curved
- 12-143-35 20cm / 8" (25mm) Curved
- 12-144-35 20cm / 8" (32mm) Curved



Smith-Peterson
12-145-20 - 12-151-20

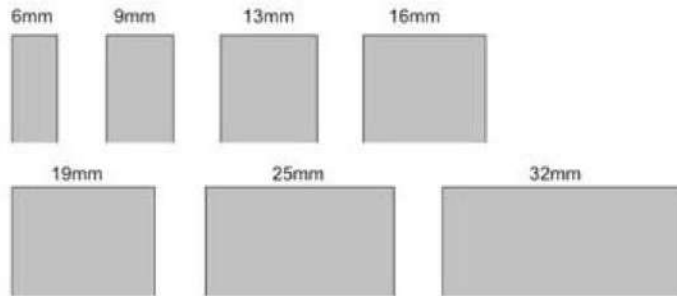

Fiber handle
Please add the symbol "FH" to the
Catalog Numbers

- 12-145-20 20cm / 8" (06mm) Straight
- 12-146-20 20cm / 8" (09mm) Straight
- 12-147-20 20cm / 8" (13mm) Straight
- 12-148-20 20cm / 8" (16mm) Straight
- 12-149-20 20cm / 8" (19mm) Straight
- 12-150-20 20cm / 8" (25mm) Straight
- 12-151-20 20cm / 8" (32mm) Straight



Smith-Peterson
12-152-20 - 12-158-20

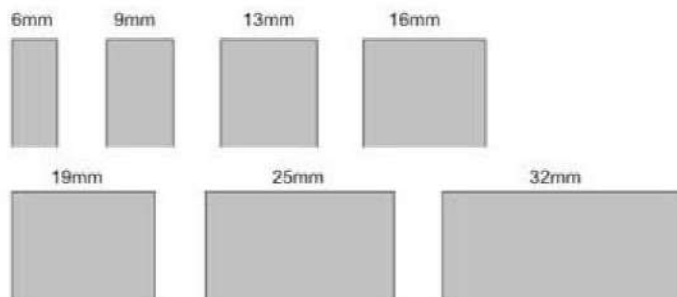

Fiber handle
Please add the symbol "FH" to the
Catalog Numbers

- 12-152-20 20cm / 8" (06mm) Curved
- 12-153-20 20cm / 8" (09mm) Curved
- 12-154-20 20cm / 8" (13mm) Curved
- 12-155-20 20cm / 8" (16mm) Curved
- 12-156-20 20cm / 8" (19mm) Curved
- 12-157-20 20cm / 8" (25mm) Curved
- 12-158-20 20cm / 8" (32mm) Curved



ORTHOPEDIC INSTRUMENTS

Chisels & Gouges



- 12-159-14 14cm / 5½" (4mm)
- 12-160-14 14cm / 5½" (6mm)
- 12-161-14 14cm / 5½" (8mm)
- 12-162-14 14cm / 5½" (10mm)
- 12-163-14 14cm / 5½" (12mm)

Chisels
12-159-14 - 12-163-14



- 12-164-14 14cm / 5½" (04mm)
- 12-165-14 14cm / 5½" (06mm)
- 12-166-14 14cm / 5½" (08mm)
- 12-167-14 14cm / 5½" (10mm)
- 12-168-14 14cm / 5½" (12mm)

Gouges
12-164-14 - 12-168-14



- 12-169-14 14cm / 5½" (04mm)
- 12-170-14 14cm / 5½" (06mm)
- 12-171-14 14cm / 5½" (08mm)
- 12-172-14 14cm / 5½" (10mm)
- 12-173-14 14cm / 5½" (12mm)

Osteotomes
12-169-14 - 12-173-14



- 12-174-14 14cm / 5½" (03mm)
- 12-175-14 14cm / 5½" (04mm)
- 12-176-14 14cm / 5½" (05mm)
- 12-177-14 14cm / 5½" (06mm)

Partsch-Chisels
12-174-14 - 12-177-14



- 12-178-14 14cm / 5½" (03mm)
- 12-179-14 14cm / 5½" (04mm)
- 12-180-14 14cm / 5½" (05mm)
- 12-181-14 14cm / 5½" (06mm)

Partsch-Chisels
12-178-14 - 12-181-14



- 12-182-24 24.5 cm / 9 1/2" (04mm)
- 12-183-24 24.5 cm / 9 1/2" (08mm)
- 12-184-24 24.5 cm / 9 1/2" (10mm)
- 12-185-24 24.5 cm / 9 1/2" (13mm)
- 12-186-24 24.5 cm / 9 1/2" (15mm)
- 12-187-24 24.5 cm / 9 1/2" (18mm)
- 12-188-24 24.5 cm / 9 1/2" (20mm)
- 12-189-24 24.5 cm / 9 1/2" (25mm)
- 12-190-24 24.5 cm / 9 1/2" (30mm)
- 12-191-24 24.5 cm / 9 1/2" (38mm)
- 12-192-24 24.5 cm / 9 1/2" (44mm)
- 12-193-24 24.5 cm / 9 1/2" (50mm)

Lambotte Osteotomes, Straight
12-182-24 - 12-193-44



- 12-194-24 24.5 cm / 9 1/2" (08mm)
- 12-195-24 24.5 cm / 9 1/2" (13mm)
- 12-196-24 24.5 cm / 9 1/2" (18mm)
- 12-197-24 24.5 cm / 9 1/2" (25mm)
- 12-198-24 24.5 cm / 9 1/2" (30mm)
- 12-199-24 24.5 cm / 9 1/2" (38mm)

Lambotte Osteotomes, Curved
12-194-24 - 12-199-24



Obwegeser Osteotomes, Curved
12-200-24
24.5 cm / 9 1/2"



Niederdellmann Osteotomes, Curved
12-201-01 24.5 cm / 9 1/2" 8mm
12-201-02 24.5 cm / 9 1/2" 11mm



ORTHOPEDIC INSTRUMENTS

Chisels & Gouges



- 12-205-08 (08mm)
- 12-205-10 (10mm)
- 12-205-12 (12mm)
- 12-205-15 (15mm)
- 12-205-20 (20mm)

Osteotomes Straight (Fiber Handle)
12-205-08 - 12-205-20
23 cm / 9"



- 12-206-08 (08mm)
- 12-206-10 (10mm)
- 12-206-12 (12mm)
- 12-206-15 (15mm)
- 12-206-20 (20mm)

Osteotomes Curved (Fiber Handle)
12-206-08 - 12-206-20
23 cm / 9"



- 12-211-04 (04mm)
- 12-211-06 (06mm)
- 12-211-08 (08mm)
- 12-211-10 (10mm)
- 12-211-12 (12mm)

Mini-Lexer Osteotomes (Fiber Handle)
12-211-04 - 12-211-12



- 12-212-04 (04mm)
- 12-212-07 (07mm)
- 12-212-10 (10mm)
- 12-212-15 (15mm)
- 12-212-20 (20mm)
- 12-212-25 (25mm)
- 12-212-30 (30mm)

Lexer Osteotomes (Fiber Handle)
12-212-04 - 12-212-30
23 cm / 9"





- 12-215-10 (10mm)
- 12-215-15 (15mm)
- 12-215-20 (20mm)

Lexer Osteotomes (Fiber Handle)
12-215-10 - 12-215-20
23 cm / 9"

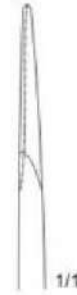

- 12-220-04 (04mm)
- 12-220-16 (06mm)
- 12-220-18 (08mm)
- 12-220-10 (10mm)
- 12-220-12 (12mm)

Mini-Lexer Gouges (Fiber Handle)
12-220-04 - 12-220-12
18 cm / 7"



- 12-225-04 (04mm)
- 12-225-08 (08mm)
- 12-225-10 (10mm)
- 12-225-12 (12mm)
- 12-225-15 (15mm)
- 12-225-20 (20mm)
- 12-225-25 (25mm)
- 12-225-30 (30mm)

Gouge for (Fiber Handle)
12-225-04 - 12-225-12
23 cm / 9"



- 12-230-04 (04mm)
- 12-230-16 (06mm)
- 12-230-18 (08mm)
- 12-230-10 (10mm)
- 12-230-12 (12mm)

Gouge for removing broken screw
(Fiber Handle)
12-230-04 - 12-230-12
23 cm / 9"



ORTHOPEDIC INSTRUMENTS

Screw Driver



Screw Driver
With Fibre handle
12-233-25
25 cm / 10"

Screw Driver
With Fibre handle
12-234-25
25 cm / 10"

Screw Driver
With Fibre handle
12-235-25
25 cm / 10"



Hudson



- 12-236-00 Set
 12-236-01 1 Hand bone drill
 12-236-02 1 Extension Piece Fig.1
 12-236-03 1 Burr Ø 10mm Fig.2
 12-236-04 1 Burr Ø 14mm Fig.3
 12-236-05 1 Burr Ø 16mm Fig.4
 12-236-06 1 Burr Ø 22mm Fig.5
 12-236-07 1 Burr Ø 13mm Fig.6



12-237-00
 28 cm / 11"



Cock Screw
 12-238-18
 18 cm / 7"



Parthes
 12-239-22
 22 cm / 8 3/4"



ORTHOPEDIC INSTRUMENTS

Bone Mallets



140 gm

Mellet, Removable Discs
12-240-25
25cm / 7 3/4"



185 gm

Mellet Mellet, Removable Discs
12-241-20
20cm / 8"



240 gm

Cottle
12-242-18
18.5cm / 7 1/4"



165 gm

Medro Mallet
12-243-19
19cm / 7 1/2"



120 gm

Medro Mallet
12-244-16
16.5cm / 6 1/2"



140 gm

Hajek
12-245-21
21.5cm / 8 1/2"



¼

Doyen
 12-246-25 25cm / 10" (120 gm)
 12-247-30 30cm / 12" (120 gm)
 12-248-35 35cm / 13½" (120 gm)



¼

Medro Mallet (Fiber Handle)
 12-249-30 30 cm / 12" (450 gm)
 12-250-35 50 cm / 19½" (900 gm)



Medro Mallet (Plastic Disc)
 12-251-25 18 cm / 7" (140 gm)



ORTHOPEDIC INSTRUMENTS

Bone Skids



12-252-15
15cm / 6"

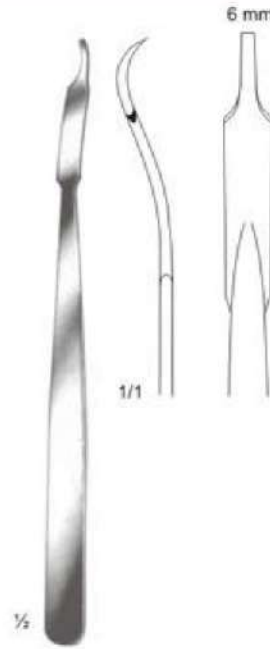

Mini-Howman
12-253-16
16.5cm / 6 1/2"

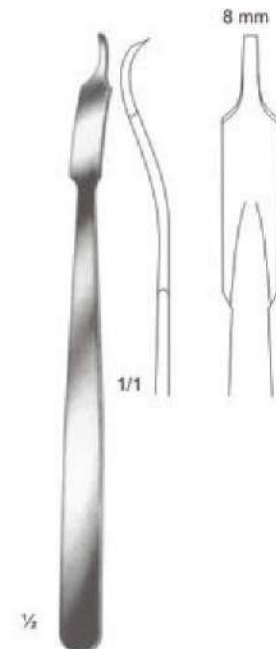

Mini-Howman
12-254-16
16.5cm / 6 1/2"



Howman
12-255-21
21cm / 8.5"



Howman
12-256-24
24cm / 9.5"



Howman
12-257-24
24cm / 9.5"



ORTHOPEDIC INSTRUMENTS

Bone Skids



Lange-Howman
12-259-26
26cm / 10½"



Howman
12-260-28
28cm / 11"



Bennet
12-261-45 (45mm)
12-261-60 (60mm)
25cm / 10"





1/2

Langenbeck
12-262-23
23cm / 9"



1/2

Langenbeck
12-263-23
23cm / 9"



1/2

Bruns
12-264-21
21cm / 8 1/2"



1/3

Bruns
12-265-20
20cm / 8"



ORTHOPEDIC INSTRUMENTS

Bone Files & Saw



Putti
12-266-24
24cm / 9½"



1/1



Putti
12-267-30
30cm / 12"



½



Putti
12-268-27
27cm / 10½"



½



Scatteriee Saw
12-269-29
29cm / 11½"

½



12-270-01 12-270-02
13 cm / 5½" 18 cm / 7"



Parallel Action

12-270-01 - 12-270-02
18cm / 7"



12-271-13
13 cm / 5½"



12-271-18
18 cm / 7"

12-271-13 - 12-271-08
18cm / 7"



12-272-14 - 12-275-18

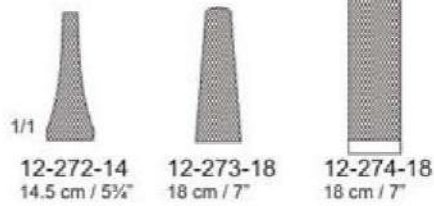

12-272-14
14.5 cm / 5¾"

12-273-18
18 cm / 7"

12-274-18
18 cm / 7"



12-275-18
18 cm / 7"



1/1



12-278-17
17 cm / 6¾"



ORTHOPEDIC INSTRUMENTS

Bone Files & Saw



12-279-16
16 cm / 6 1/4"



12-280-16
16 cm / 6 1/4"



12-281-14
14.5 cm / 5 3/4"

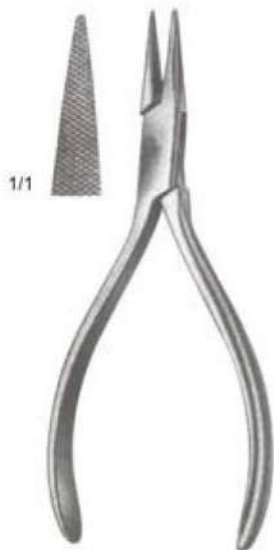

12-283-14
14 cm / 5½"

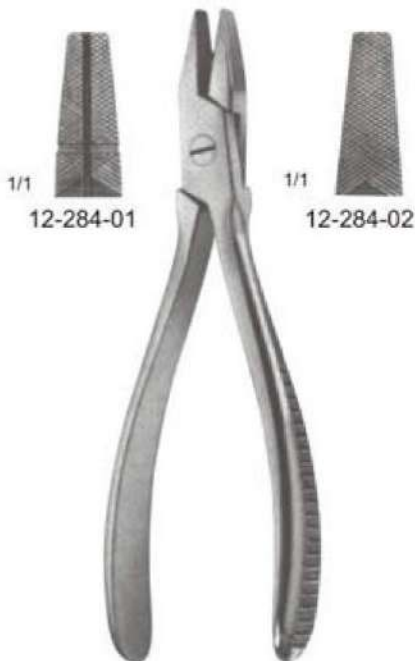

12-284-01 - 12-284-02
17 cm / 6¾"



12-285-19
19 cm / 7½"



12-286-16
16 cm / 6¼"



12-287-16
16 cm / 6¼"



12-288-17
17 cm / 6¾"



12-289-18
18 cm / 7¼"



ORTHOPEDIC INSTRUMENTS

TC Wire Cutting Pliers

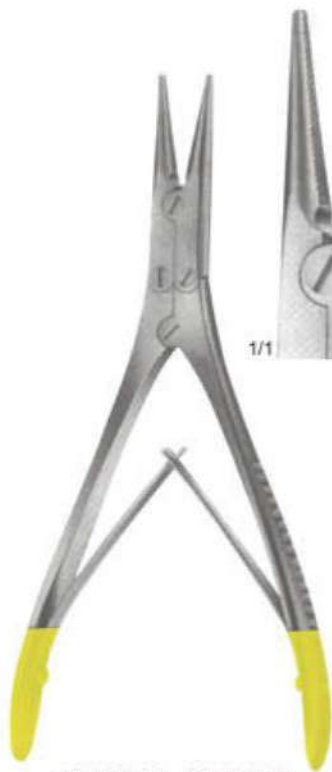

12-290-14 - 12-292-18
18 cm / 7"

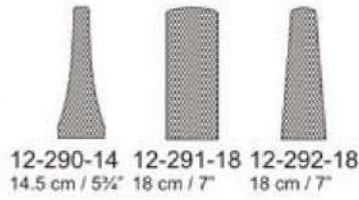

Kirschner TC
12-293-47
47 cm / 18 1/2"



Wire Cutter TC
12-294-18
18.5 cm / 7"



Wire Cutter TC
12-295-22
22 cm / 8 1/2"





Hercules TC
12-296-47 47 cm / 18½"
12-297-54 54 cm / 21¼"

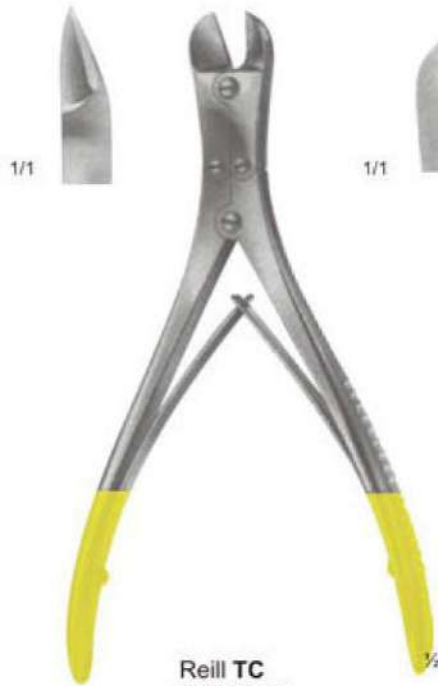

Reill TC
12-298-17
17.5 cm / 7"



End Cutter TC
12-299-18
18 cm / 7"



Wire Cutter TC
12-300-23
23.5 cm / 9¼"



Mini Wire Cutter TC
12-301-14
14 cm / 5½"

ORTHOPEDIC INSTRUMENTS

Bending Irons/Plates Benders



12-302-01

Bending Irons
12-302-01 - 12-302-02



12-302-02



Bending Irons
12-303-16
16 cm / 6 1/4"



Jewett
12-304-20
20 cm / 8"



Plate bender
12-305-25
25 cm / 10"

RETRACTORS

10

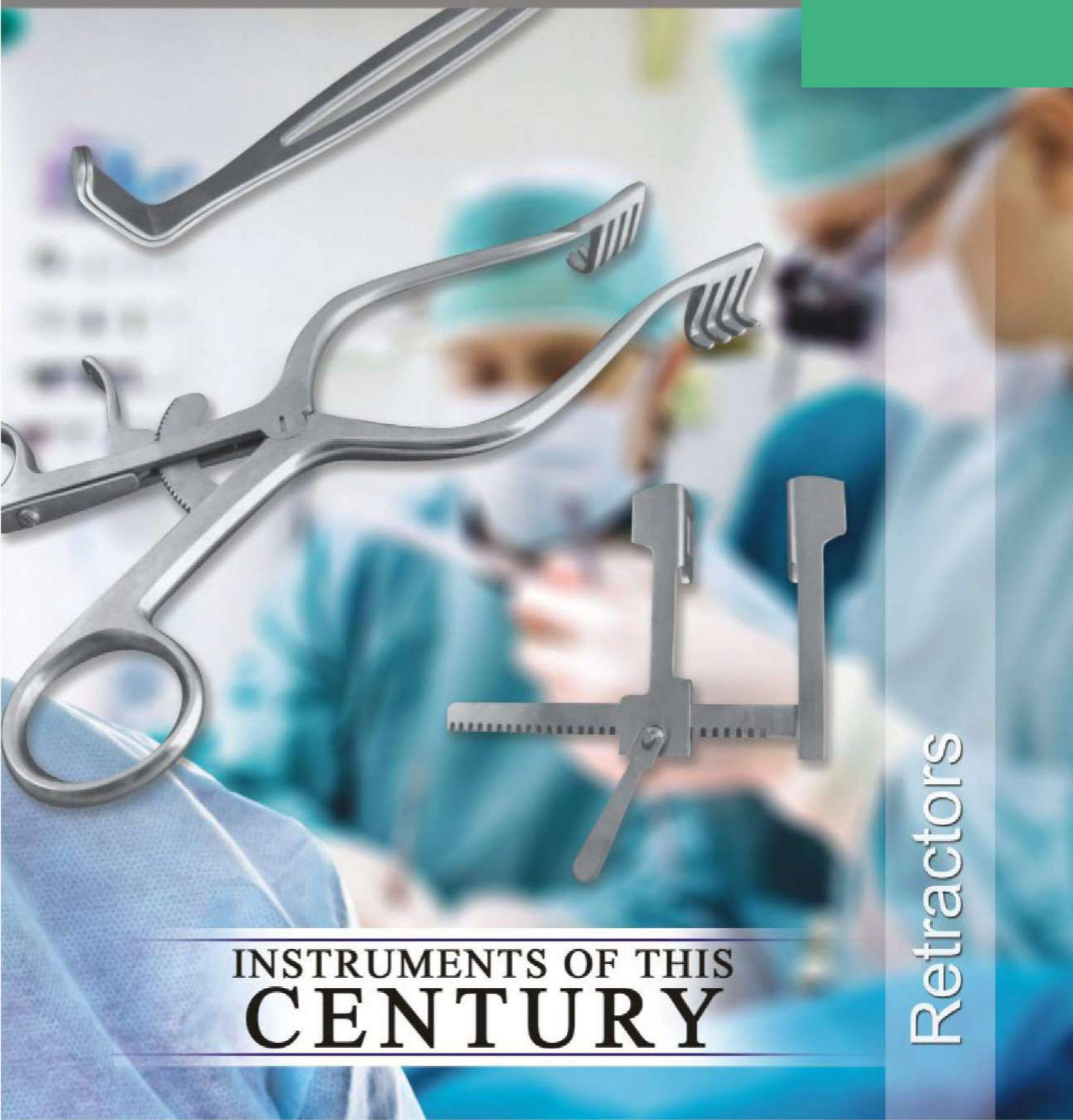

INSTRUMENTS OF THIS
CENTURY

Retractors

RETRACTORS

Finger Retractors



Sharp



09-001-01



09-001-02



Blunt



09-002-01



09-002-02



1/1

09-001-03



09-001-04



1/1

09-002-03



09-002-04

09-001-01 - 09-001-04
16.5 cm / 6 1/2"

09-002-01 - 09-002-04
16.5 cm / 6 1/2"



09-003-01



Sharp



09-003-02



09-003-03



1/2
09-003-04



09-004-01



Blunt



09-004-02



09-004-03



1/2
09-004-04

09-003-01 - 09-003-04
16.5 cm / 6 1/2"

09-003-01 - 09-003-04
16.5 cm / 6 1/2"



Sharp



Blunt

1/1

09-005-01

09-005-02

Senn-muller
09-005-01 - 09-005-02
16.5 cm / 6 1/2"

RETRACTORS

Volkman Retractors

Inches

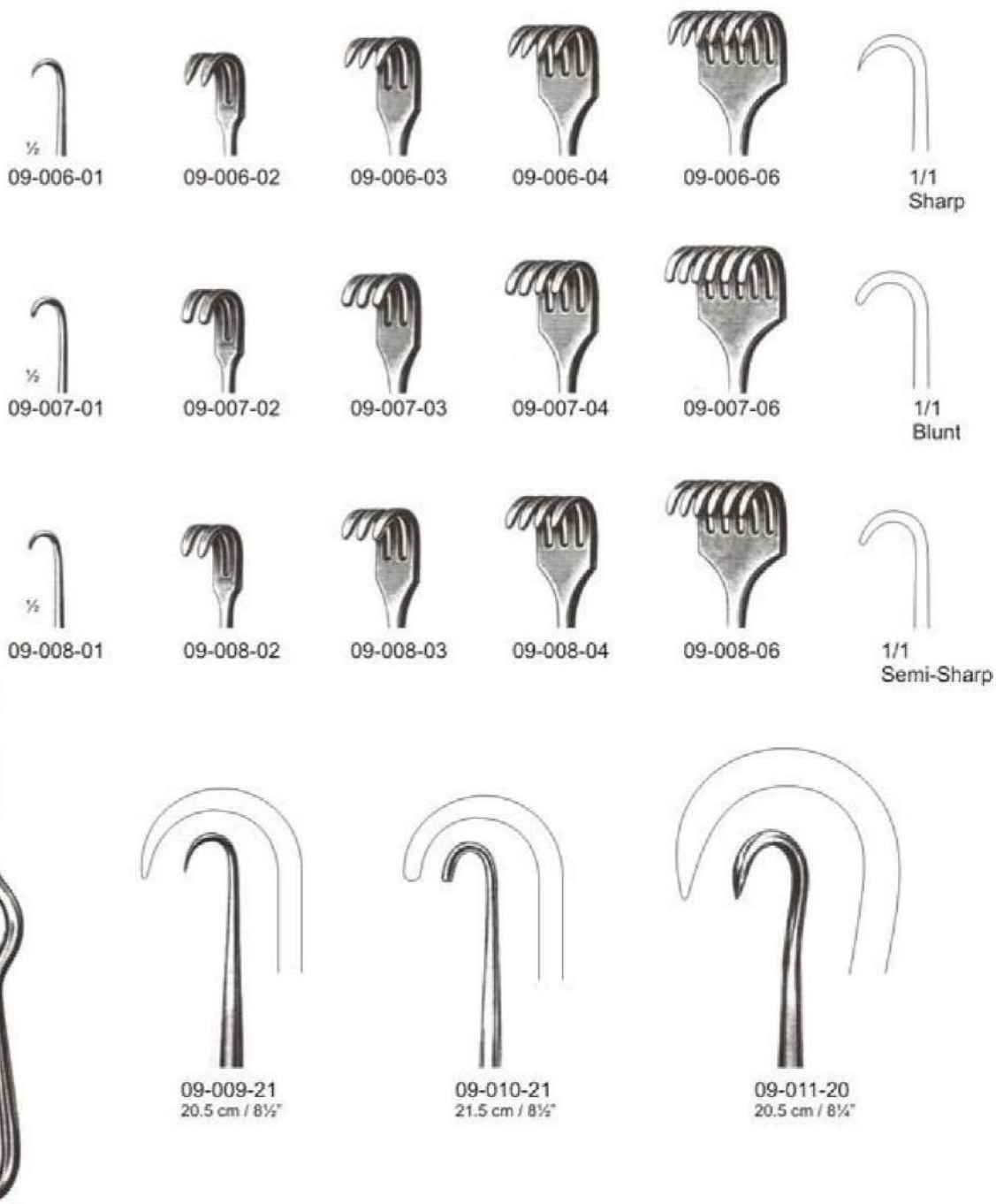

Volkman
09-006-01 - 09-011-20
22 cm / 8 $\frac{3}{4}$ "

RETRACTORS

Volkman & Langenbeck Retractors



Volkman
09-012-01 - 09-013-06
25 cm / 8½"

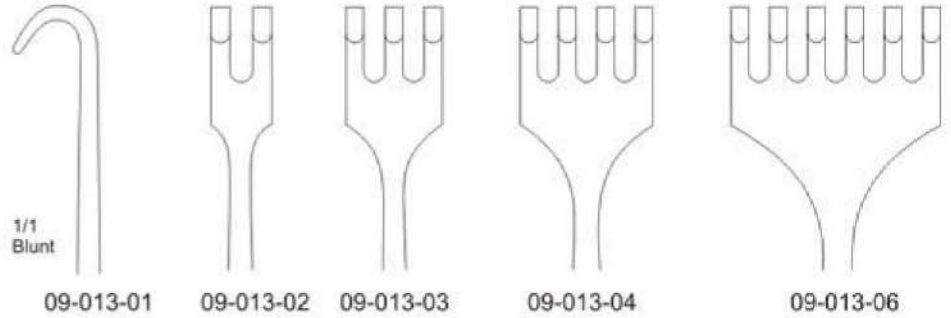
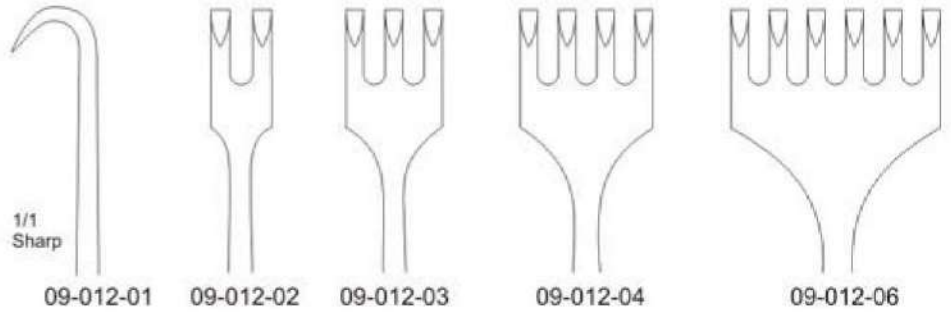

Langenbeck
09-014-01 - 09-014-05
22 cm / 8½"



Langenbeck
09-015-01 - 09-015-05
22 cm / 8½"

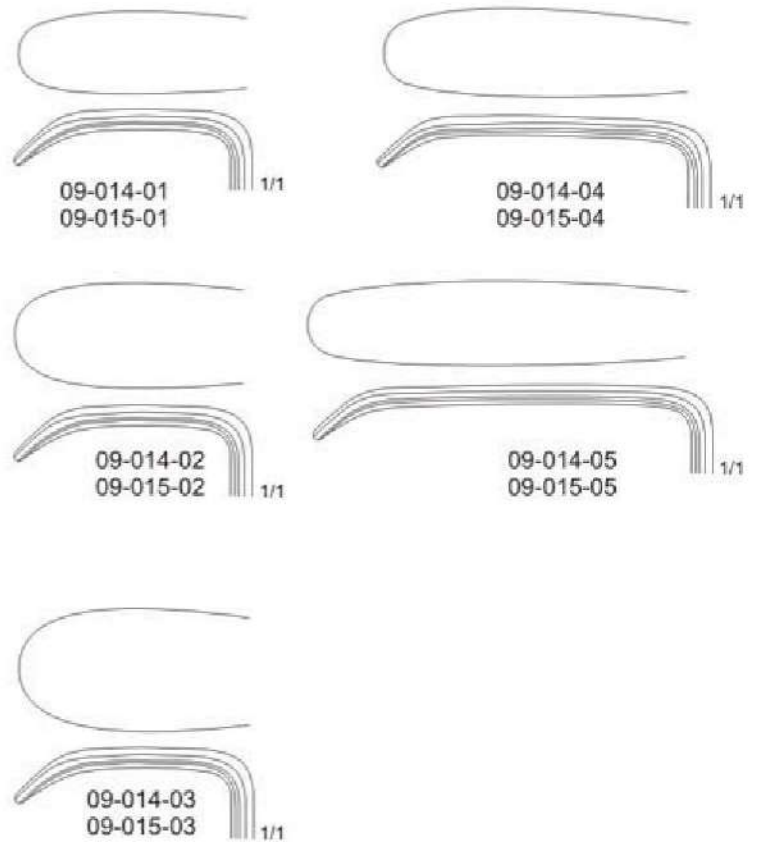

RETRACTORS

Koacher & Middledorf Retractors

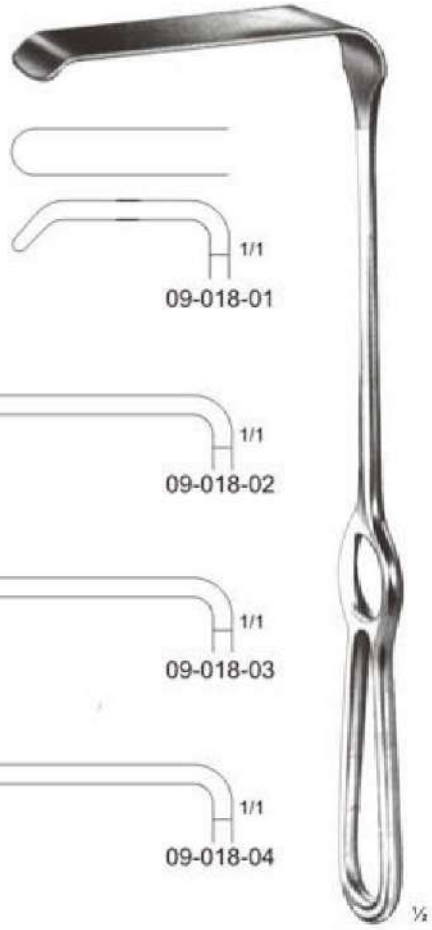
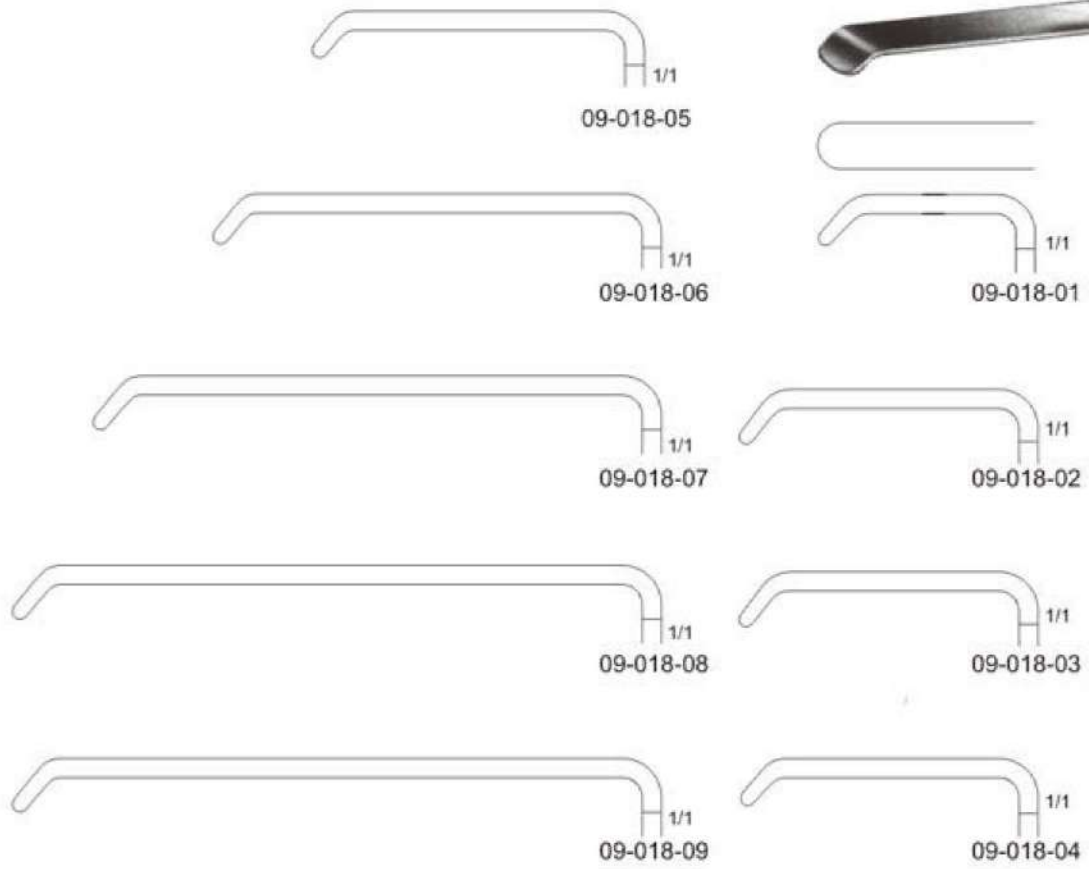

Koacher
09-018-01 - 09-018-09



Middledorf
09-019-01 - 09-019-03

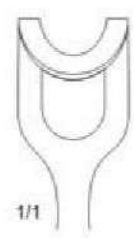

09-019-01
21.5 cm / 8 1/2"

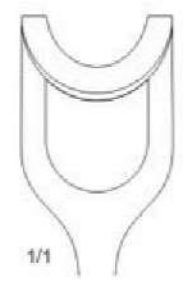

09-019-02
22 cm / 8 3/4"

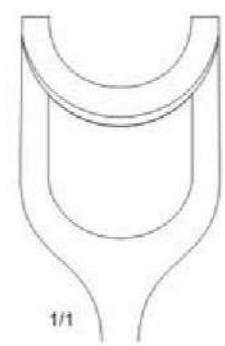

09-019-03
23.5 cm / 9 1/2"

RETRACTORS

Richardson Retractors

Inches



Taylor
09-020-16 - 09-021-16
16 cm / 6 1/2"

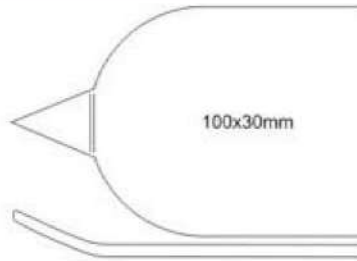

100x30mm

09-021-16

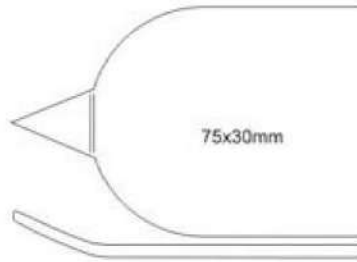

75x30mm

09-020-16



L - 49x38mm
S - 28x20mm



Richardson
09-023-01 - 09-023-03
24 cm / 9 1/2"



09-023-01
28x20mm

1/1

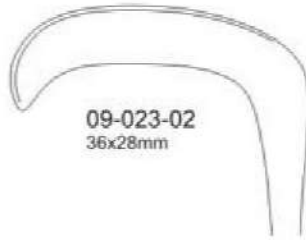

09-023-02
36x28mm

1/1

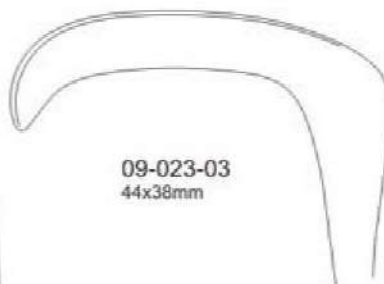

09-023-03
44x38mm

1/1

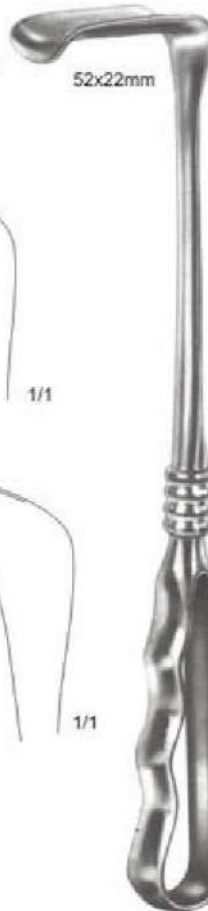

52x22mm



70x50mm

S - 36x28mm
L - 71x43mm

Richardson Eastman
09-022-00 Set of 2
09-022-01 Small
09-022-02 Large

Richardson
09-024-24
24 cm / 9 1/2"

Kelly
09-025-26
26 cm / 10 1/2"

RETRACTORS

Finger Retractors



Israel
09-026-01 - 09-026-04
23.5 cm / 9 1/4"



09-026-01
40x40mm

1/1



09-026-03
50x60mm

1/1



09-026-02
45x50mm

1/1

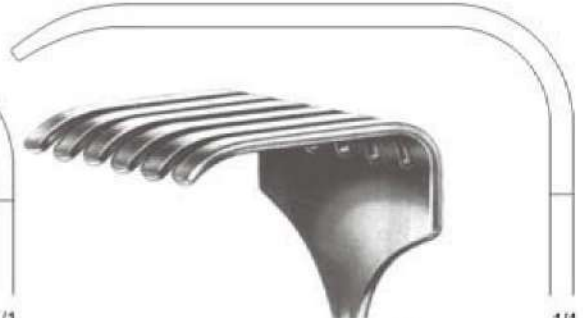

09-026-04
70x70mm

1/1



50x85mm

1/2

Doyen
09-027-25
25 cm / 10"



Kocher
09-028-01 70x25mm
09-028-02 80x45mm
09-028-03 80x55mm
09-028-04 80x65mm
23.5 cm / 9 1/4"



RETRACTORS

Hand Retractors



Farabeuf
09-030-00
12 cm / 4 3/4"



Farabeuf
09-031-00
15 cm / 6"



Baby-Roux
09-032-00
13 cm / 5 1/4"



Deaver
09-033-30
30 cm / 12"

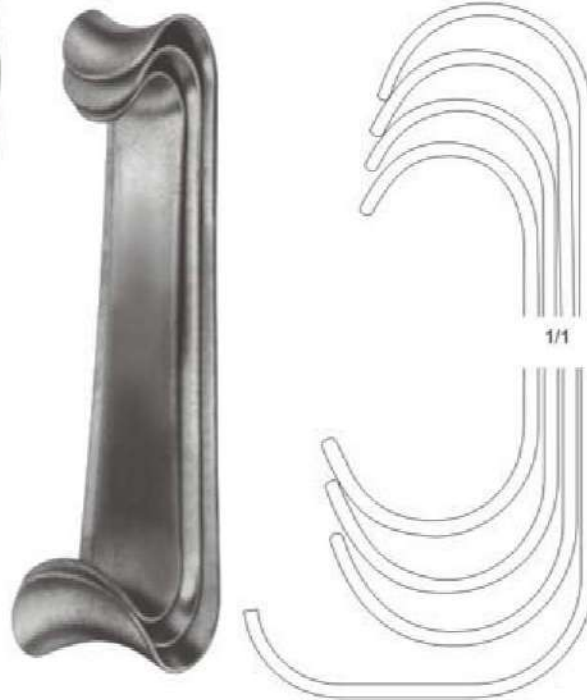

Roux
09-034-00 Set Of 3
09-034-01 15 cm
09-034-02 16 cm
09-034-03 17 cm



Parker
09-035-00
13.5 cm / 5 1/2"

RETRACTORS

Self Retaining Retractors



Us-Army Retractor
09-036-00
21 cm / 8¼"



Jansen
09-037-10
10 cm / 4"

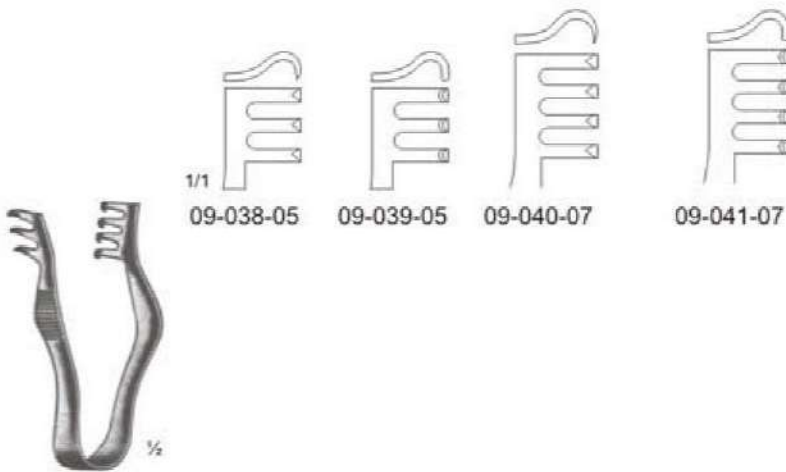

Finsen
09-038-05 - 09-041-07
5 cm / 2"
7 cm / 2½"

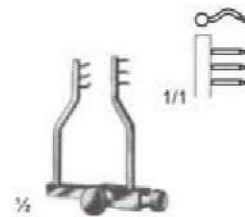

Logan
09-042-04
4 cm / 2"



RETRACTORS

Hand & Infant Retractors



Gelpi
09-043-17
13.5 cm / 5 1/4"

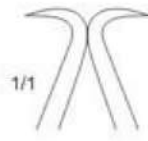

1/1



Gelpi
09-044-17
17.5 cm / 7"

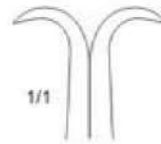

1/1



Debakey
09-045-10
10 cm / 4"

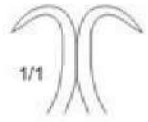

1/1



Anderson-Adson
09-046-19
19.5 cm / 8"

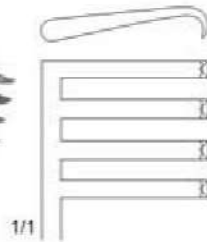

1/1



Weitlaner
09-047-01 - 09-047-02
20 cm / 8"

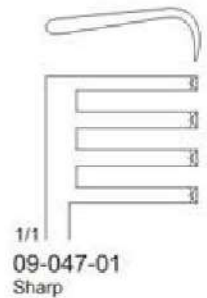

1/1

09-047-01
Sharp



1/1

09-047-02
Blunt



RETRACTORS

Weitlaner Retractors

Inches

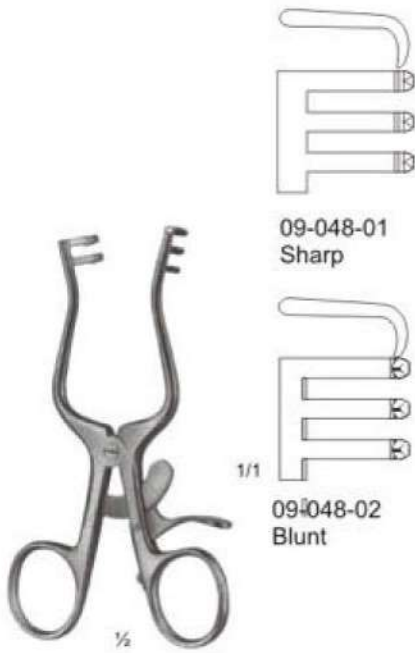

Weitlaner-Locktite
09-048-01 - 09-048-02
10 cm / 4 1/4"

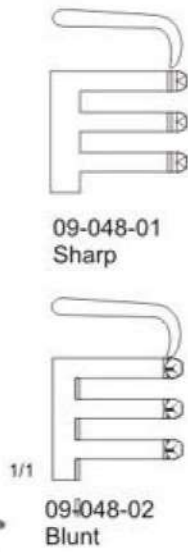

09-048-01
Sharp

09-048-02
Blunt



Weitlaner
09-049-13 - 09-050-16



09-049-13
13 cm / 5"
Sharp

09-050-13
13 cm / 5"
Blunt



09-049-16
16.5 cm / 6 1/2"
Sharp

09-050-16
16.5 cm / 6 1/2"
Blunt



Weitlaner-Wullstein
09-051-01 - 09-051-02
13 cm / 5"



09-051-01

09-051-02



Mollison
09-052-15
15 cm / 6"



1/1
Sharp



RETRACTORS

Self Retaining Retractors



Beckmann
09-053-31
31 cm / 12 1/2"



Adson
09-054-32
32 cm / 12 1/2"

RETRACTORS

Self Retaining Retractors



Beckmann-Adson
09-055-01 - 09-055-04
31 cm / 12 1/4"

1/1

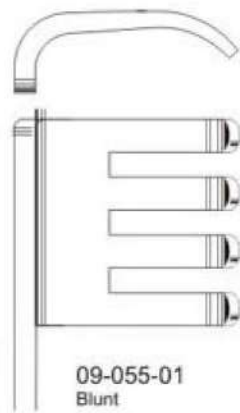

09-055-01
Blunt

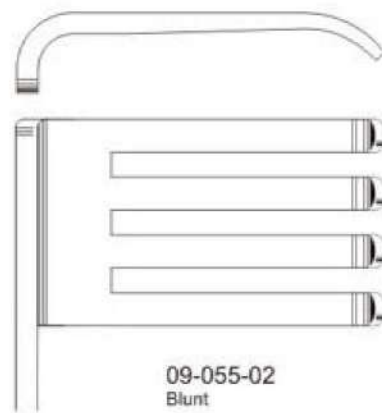

09-055-02
Blunt

1/1

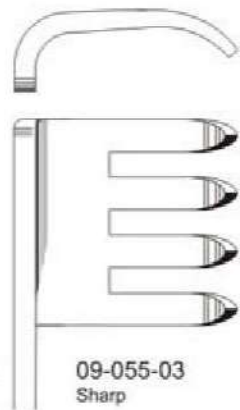

09-055-03
Sharp

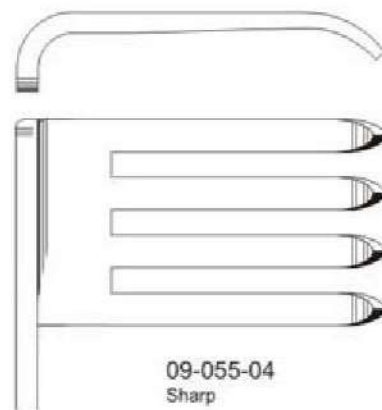

09-055-04
Sharp



Inches

RETRACTORS

Self-Retaining Laminectomy Retractors



Contour
09-070-14
14 cm / 5 1/2"



Meyerding
09-071-32 32x25mm
09-071-54 54x25mm
09-071-60 60x25mm
09-071-61 60x19mm
20 cm / 8"



Markham-Meyerding
09-072-18
18 cm / 7"



Markham-Meyerding
09-073-18
18 cm / 7"



Inches

RETRACTORS

Rib Spreader

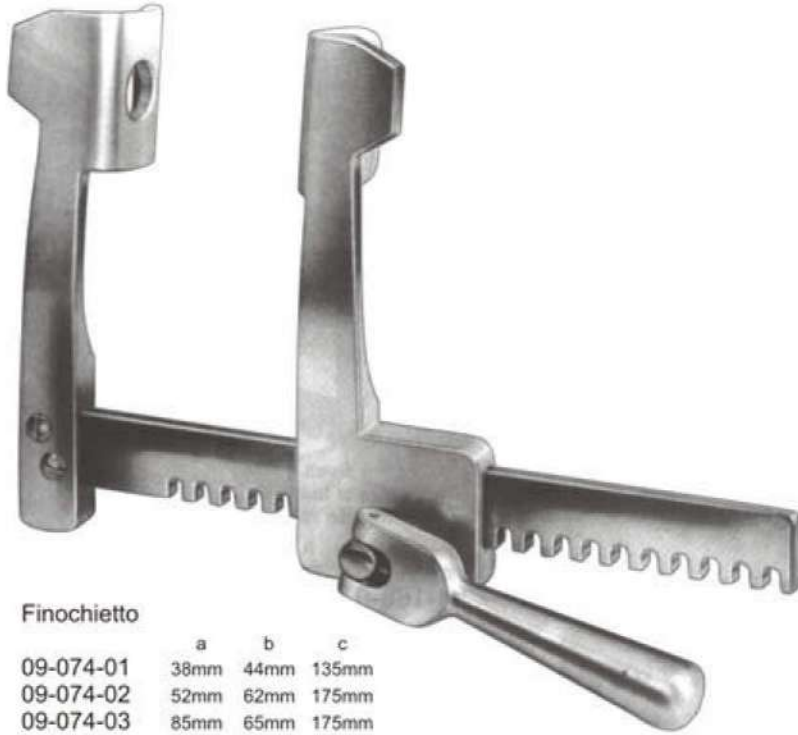

Finochietto

	a	b	c
09-074-01	38mm	44mm	135mm
09-074-02	52mm	62mm	175mm
09-074-03	85mm	65mm	175mm

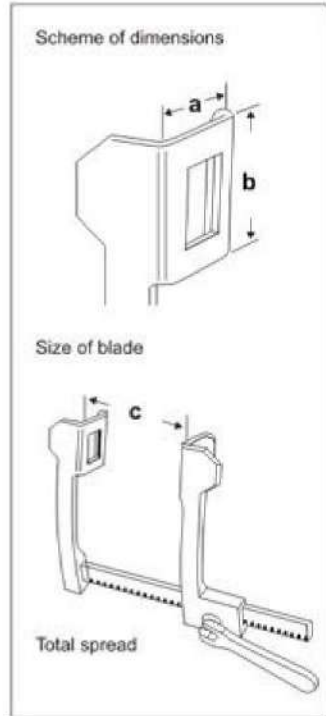

Finochietto-Baby Haight

	a	b	c
09-075-00	31mm	31mm	100mm



Finochietto-Child

	a	b	c
09-076-00	15mm	18mm	75mm

DERMAL & RECTAL

11



INSTRUMENTS OF THIS
CENTURY

Dermal & Rectal Instruments

DERMAL & RECTAL INSTRUMENTS

Dermal Curettes



DERMAL & RECTAL INSTRUMENTS

Nail Cutters & Nippers

Inches



Nail Cutter
 11-007-14 14cm / 5½"
 11-007-16 14cm / 5½"



Nail Cutter
 11-008-13
 13cm / 5"



Nail Cutter
 11-009-14
 14cm / 5½"



Turnbull
 11-010-11 11cm / 4½"
 11-010-13 13cm / 5"



Nail Nippers
 11-011-11 11cm / 4½"
 11-011-13 13cm / 5"
 11-011-15 15cm / 6"

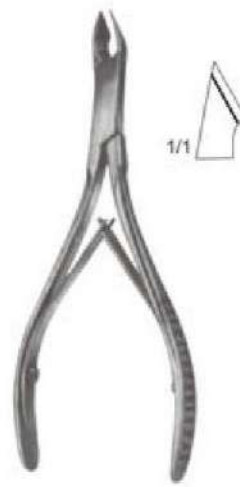

Nail Nippers
 11-012-11 11cm / 4½"
 11-012-13 13cm / 5"



Nail Nippers
 11-013-10 10cm / 4½"



DERMAL & RECTAL INSTRUMENTS

Cuticle Scissors, Dermal Punches & Rectal Speculum



Cuticle
10cm / 4"

Str 11-017-10
Cvd 11-018-10



Keyes
11-019-01 - 11-019-07
11cm / 4 1/2"

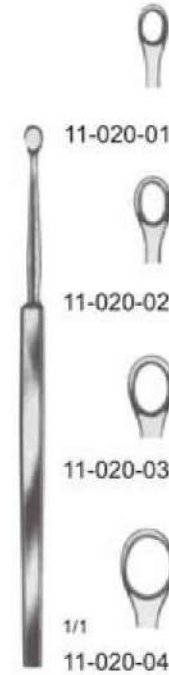

Fox
11-020-01 - 11-020-04
14cm / 5 1/2"



Pratt
11-021-15
15cm / 6"



Sims
11-022-15
15cm / 6"



Czerny
11-023-21
21cm / 8 1/4"



Inches

DERMAL & RECTAL INSTRUMENTS

Rectal Speculam & Anoscopes



1/2
Mathieu
11-024-20
20cm / 7 3/4"



70 x 22 mm
1/2
Barr
11-025-17
17cm / 6 1/2"



1/2
Hirschmann Anoscope
11-026-01 14x64mm
11-026-02 17x70mm
11-026-03 20x89mm



87mm
Ives-Fansler
Anoscope
11-027-14
14.5mm / 5/8"